



---

west virginia department of environmental protection

---

Office of Oil and Gas  
601 57<sup>th</sup> Street, S.E.  
Charleston, WV 25304  
(304) 926-0450  
fax: (304) 926-0452

Austin Caperton, Cabinet Secretary  
[www.dep.wv.gov](http://www.dep.wv.gov)

Wednesday, February 19, 2020  
PERMIT MODIFICATION APPROVAL  
Horizontal 6A / New Drill

EQT PRODUCTION COMPANY  
625 LIBERTY AVE., SUITE 1700

PITTSBURGH, PA 15222

Re: Permit Modification Approval for OXF43H34  
47-017-06885-00-00

**Lateral Extension**

EQT PRODUCTION COMPANY

The Office of Oil and Gas has reviewed the attached permit modification for the above referenced permit. The attached modification has been approved and well work may begin. Please be reminded that the oil and gas inspector is to be notified twenty-four (24) hours before permitted well work is commenced.

If there are any questions, please feel free to contact me at (304) 926- 0450.

James A. Martin  
Chief

A blue ink signature of James A. Martin, written in a cursive style.

Operator's Well Number: OXF43H34  
Farm Name: CATHY JEAN WETZEL, ET AL  
U.S. WELL NUMBER: 47-017-06885-00-00  
Horizontal 6A New Drill  
Date Modification Issued: February 19, 2020

Promoting a healthy environment.

EQT Production  
Hydraulic Fracturing Monitoring Plan  
Pad ID: OXF43  
County: Doddridge

December 10, 2019

RECEIVED  
Office of Oil and Gas

DEC 20 2019

WV Department of  
Environmental Protection

## **Purpose**

The purpose of this pad-specific Hydraulic Fracturing Monitoring Plan is to identify and notify conventional well operators near EQT hydraulic fracturing in Doddridge County, WV prior to hydraulic fracturing at the following EQT wells on the OXF43 pad: 516228, 516229, 516230, 516232, 516238, 516240, OXF43H32, OXF43H34 and OXF43H35.

Due to the requirements under 35CSR8 5.11, the permittee is required to review the area surrounding the proposed well pad so as to identify and evaluate potential conduits for unintended fracture propagation.

A report is required to be submitted along with a well work permit application.

The plan is being implemented as an additional safety measure to be utilized in conjunction with existing best management practices and emergency action plans for the site. These additional measures include coordination with well operators of the timing and location of the hydraulic fracturing, establishment of measures well operators should implement, and assurance that the OOG is notified of the timeline, as well as any issues that may arise during fracturing.

### **1. Communications with Well Operators**

EQT, using available data (WV Geological Survey, WVDEP website, and IHS data service), has identified all known wells and well operators within 500 feet of this pad and the lateral sections that are known or could reasonably be expected to be within range of the fracture propagation. A map showing these wells along with a list of the wells and operators is included in **Attachment A**.

EQT will notify these operators of the hydraulic fracturing schedule for these wells, and coordinate with them throughout the fracturing process.

EQT will recommend to these operators at a minimum to:

1. Inspect their surface equipment prior to fracturing to establish integrity and establish pre-frac well conditions
2. Observe wells closely during and after fracturing and monitor for abnormal increases in water, gas or pressure
3. Inspect or install master valves or other necessary equipment for wellhead integrity capable of a pressure recommended by EQT
4. Notify the OOG and EQT if any changes in water, gas production, pressure, or other anomalies are identified

### **2. Reporting**

EQT will provide information relating to the hydraulic fracturing schedule, communication with other operators, and ongoing monitoring of the work upon request of OOG or immediately in the event of any noted abnormalities.

RECEIVED  
Office of Oil and Gas

DEC 30 2019

WV Department of  
Environmental Protection



Doddridge

RECEIVED  
Office of Oil and Gas

DEC 20 2019

WV Department of  
Environmental Protection

Ritchie

**EQT**  
EQT Corporation  
625 Liberty Avenue  
Pittsburgh, PA 15222

OXF43 - South

**Vertical Offsets and  
Foreign Laterals  
within 1500'**

- Legend**
- OXF43OV
  - Well Pad Sites
  - Well Lateral\_FM Formation**
  - Genesee
  - Marcellus
  - Utica

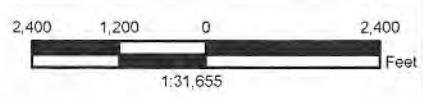

**Disclaimer:**

This map is confidential and is to be used only for the express informational purposes for which it was created. Unauthorized use, copying, or dissemination is strictly prohibited. EQT does not warrant the accuracy of the location of any items shown on this map, including, but not limited to, any structures, well or pipeline facilities, property boundaries, topography, roadways, or waterways. The items shown on the map may not have been placed on the map using survey lines or GPS coordinates. The specific location of any of the map items should be determined by a field survey performed by a licensed surveyor upon consultation with EQT.



WellID	WellStatus	date	FmatTD	Permit	Operator	Longitude	Latitude	TargetFm	DatumEleva	TD SS	TD
4701700025	UNK	8/13/1930		00025	PGH & WV GAS	-80.8015	39.1659		1012.0000	-1490.0000	2502
4701700104	GAS	9/21/1939		00104	EPC	-80.8015	39.1596		1095.0000	-1397.0000	2492
4701700168	GAS	10/15/1946		00168	P & M OIL	-80.7932	39.1491		905.0000	-1416.0000	2321
4701700172	GAS	12/7/1946		00172	P & M OIL	-80.7903	39.1529		955.0000	-1262.0000	2217
4701700185	GAS	2/11/1919		00185	EPC	-80.7847	39.1492		1103.0000	-905.0000	2008
4701700207	GAS	10/5/1954		00207	P & M OIL	-80.7910	39.1473		883.0000	-853.0000	1736
4701700279	GAS	9/9/1959		00279	DORIS G FUEL	-80.7785	39.1244		1197.0000	-945.0000	2142
4701700365	O&G	9/2/1960		00365	BEECHLICK OIL	-80.7807	39.1534		1152.0000	-881.0000	2033
4701700431	O&G	11/26/1960		00431	ASH & CHAPMAN	-80.7751	39.1460		937.0000	-967.0000	1904
4701700613	GAS-P	10/14/1961		00613	PENNZOIL	-80.7722	39.1363		954.0000	-1140.0000	2094
4701700766	O&G	8/2/1962		00766	WILLIAMS OIL & GAS	-80.7826	39.1528		935.0000	-912.0000	1847
4701700835	O&G-P	7/23/1962		00835	EDWARD DOLLY	-80.7762	39.1483		1068.0000	-1016.0000	2084
4701701074	GAS	2/21/1964		01074	WILLIAMS OIL & GAS	-80.7837	39.1506		949.0000	-1510.0000	2459
4701701282	O&G	8/31/1965		01282	PENNZOIL	-80.7829	39.1468		1061.0000	-971.0000	2032
4701701283	O&G	8/17/1965		01283	PENNZOIL	-80.7785	39.1490		1041.0000	-977.0000	2018
4701701291	O&G	9/3/1965		01291	PENNZOIL	-80.7825	39.1424		1027.0000	-994.0000	2021
4701701305	DRY	10/18/1965		01305	PENNZOIL	-80.7788	39.1464		893.0000	-1007.0000	1900
4701701307	O&G	9/18/1965		01307	PENNZOIL	-80.7807	39.1446		927.0000	-993.0000	1920
4701701316	O&G	1/5/1966		01316	EPC	-80.7812	39.1503		1131.0000	-894.0000	2025
4701701317	OIL	2/27/1919		01317	EPC	-80.7845	39.1416		1067.0000	-934.0000	2001
4701701325	DRY	10/27/1965		01325	QUAKER STATE	-80.7749	39.1301		1008.0000	-1072.0000	2080
4701701329	O&G	10/28/1965		01329	PENNZOIL	-80.7792	39.1427		1180.0000	-990.0000	2170
4701701367	O&G	10/19/1966		01367	EPC	-80.7855	39.1474		1071.0000	-959.0000	2030
4701701408	O&G	10/23/1966		01408	MID AMERICAN EXPLORATION	-80.7756	39.1350		1241.0000	-1059.0000	2300
4701701429	O&G	3/31/1967		01429	EPC	-80.7853	39.1450		883.0000	-933.0000	1816
4701701433	GAS-P	2/9/1967		01433	FRANCIS FRIESTAD	-80.8172	39.1747		913.0000	-871.0000	1784
4701701452	O&G	6/29/1967		01452	EPC	-80.7878	39.1429		1091.0000	-936.0000	2027
4701701470	GAS	7/11/1968		01470	MID AMERICAN EXPL	-80.7725	39.1350		1244.0000	-1635.0000	2879
4701701471	O&G	9/6/1967		01471	MID AMERICAN EXPLORATION	-80.7692	39.1354		1046.0000	-1607.0000	2653
4701701538	O&G	3/1/1969		01538	PENNZOIL	-80.7828	39.1389		1045.0000	-965.0000	2010
4701701560	O&G	10/8/1969		01560	EPC	-80.7873	39.1407		1022.0000	-921.0000	1943
4701701623	O&G-P	8/8/1971		01623	WARREN DRILLING	-80.7952	39.1564		1226.0000	-1474.0000	2700
4701701881	O&G	5/27/1978		01881	EPC	-80.7863	39.1419		918.0000	-975.0000	1893
4701701885	OIL	5/23/1978		01885	EPC	-80.7876	39.1467		863.0000	-1030.0000	1893
4701701966	GAS	12/2/1924		01966	CONSOLIDATED GAS	-80.7742	39.1372		940.0000	-1580.0000	2520
4701702047	GAS	5/23/1918		02047	EPC	-80.7981	39.1682		0.0000	-1907.0000	1907
4701702048	GAS	5/18/1918		02048	EPC	-80.7876	39.1695		0.0000	-1944.0000	1944
4701702051	GAS	7/5/1918		02051	EPC	-80.7980	39.1521		0.0000	-1801.0000	1801
4701702055	GAS-P	1/1/1918		02055	EPC	-80.7921	39.1585		1097.0000	-542.0000	1639
4701702057	P&A	12/13/1918		02057	EQUITRANS	-80.7986	39.1643		985.0000	-530.0000	1515
4701702068	GAS	2/2/1920		02068	EPC	-80.7936	39.1665		0.0000	-1833.0000	1833
4701702107	GAS	7/14/1930		02107	EPC	-80.8017	39.1658		1012.0000	-814.0000	1826
4701702113	P&A	5/5/1920		02113	EPC	-80.8020	39.1684		0.0000	-2485.0000	2485
4701702114	P&A	10/15/1920		02114	EPC	-80.8047	39.1611		0.0000	-2400.0000	2400
4701702115	GAS-P	10/14/1924		02115	EPC	-80.8118	39.1634		1180.0000	-722.0000	1902
4701702380	GAS	5/7/1919		02380	EPC	-80.7819	39.1508		1068.0000	-1025.0000	2093
4701702386	GAS	2/19/1914		02386	EPC	-80.7858	39.1383		1000.0000	-1604.0000	2604
4701703218	GAS	11/13/1983		03218	TRI DON	-80.7741	39.1257		1250.0000	-4054.0000	5304
4701703582	GAS	10/15/1987		03582	CNG	-80.7771	39.1480		1010.0000	-4332.0000	5342
4701703585	O&G	10/23/1987		03585	MERT DEVELOPMENT	-80.8056	39.1531		920.0000	-4338.0000	5258
4701703594	GAS	10/10/1987		03594	TERM ENERGY	-80.8067	39.1652		958.0000	-4073.0000	5031
4701703642	GAS	6/27/1988		03642	TERM ENERGY	-80.7872	39.1696		1228.0000	-4204.0000	5432
4701703816	GAS	9/20/1990		03816	ECA	-80.8027	39.1576		1065.0000	-4170.0000	5235
4701703817	GAS	6/21/1990		03817	ECA	-80.7986	39.1600		1210.0000	-4110.0000	5320
4701703828	GAS	9/28/1990		03828	ECA	-80.7880	39.1589		920.0000	-4187.0000	5107
4701703831	GAS	9/18/1990		03831	ECA	-80.7934	39.1583		1250.0000	-4172.0000	5422
4701703832	GAS	9/20/1990		03832	ECA	-80.7924	39.1545		1092.0000	-4191.0000	5283
4701703954	GAS	6/30/1992		03954	TERM ENERGY	-80.8137	39.1677		895.0000	-4065.0000	4960
4701704033	GAS	9/15/1993		04033	TERM ENERGY	-80.7975	39.1646		970.0000	-4030.0000	5000
4701704710	GAS	1/22/2003		04710	KEY OIL	-80.7932	39.1675		1206.0000	-4137.0000	5343
4701704711	GAS	1/20/2003		04711	KEY OIL	-80.8018	39.1676		1215.0000	-4126.0000	5341
4701704728	GAS	4/30/2004		04728	DOMINION	-80.7836	39.1668		1135.0000	-1585.0000	2720
4701704740	GAS	10/15/2003		04740	KEY OIL	-80.7835	39.1578		1215.0000	-4132.0000	5347
4701704741	GAS	10/4/2003		04741	KEY OIL	-80.7809	39.1617		1202.0000	-4145.0000	5347
4701704818	GAS	2/20/2005		04818	KEY OIL	-80.7754	39.1472		959.0000	-1721.0000	2680
4701704935	GAS	2/25/2005		04935	KEY OIL	-80.7880	39.1666		1203.0000	-1559.0000	2762
4701704936	GAS	5/13/2005		04936	KEY OIL	-80.7892	39.1638		1257.0000	-1550.0000	2807
4701704938	GAS	5/25/2005		04938	KEY OIL	-80.7919	39.1665		1028.0000	-1555.0000	2583
4701704939	GAS	6/2/2005		04939	KEY OIL	-80.7914	39.1686		1204.0000	-1567.0000	2771
4701704942	GAS	10/14/2005		04942	DOMINION	-80.7875	39.1653		1171.0000	-1591.0000	2762
4701704943	GAS	12/5/2005		04943	DOMINION	-80.7842	39.1623		984.0000	-1526.0000	2510

RECEIVED  
 Office of Oil and Gas  
 DEED 2 0 2019  
 WV Department of  
 Environmental Protection

4701704946	GAS	11/29/2005	04946	DOMINION	-80.7883	39.1606	1123.0000	-1597.0000	2720
4701705031	GAS	6/24/2004	05031	SPENCER ENTERPRISES	-80.8070	39.1557	0.0000	-2070.0000	2070
4701705032	GAS	6/22/2004	05032	SPENCER ENTERPRISES	-80.8035	39.1582	0.0000	-2730.0000	2730
4701705037	GAS	6/30/2004	05037	SPENCER ENTERPRISES	-80.8088	39.1592	0.0000	-1950.0000	1950
4701705058	GAS	8/31/2005	05058	SPENCER ENTERPRISES	-80.7831	39.1593	0.0000	-2285.0000	2285
4701705161	GAS	6/28/2006	05161	KEY OIL	-80.7948	39.1698	1100.0000	-1531.0000	2631
4701705162	GAS	6/28/2006	05162	KEY OIL	-80.7983	39.1668	1201.0000	-1554.0000	2755
4701705301	GAS	2/2/2007	05301	EPC	-80.7979	39.1488	986.0000	-4416.0000	5402
4701705629	GAS	9/4/2008	05629	EPC	-80.7950	39.1480	866.0000	-5466.0000	6332
4701730263	GAS	10/24/1918	30263	I H BEREN	-80.7889	39.1642	1159.0000	-895.0000	2054
4701730337	GAS	6/24/1917	30337	PGH & WV GAS	-80.8038	39.1553	1084.0000	-874.0000	1958
4701730729	GAS	5/17/1919	30729	HOPE NAT GAS	-80.7747	39.1461	979.0000	-1547.0000	2526
4701731052	GAS	1/8/1919	31052	HOPE NAT GAS	-80.7828	39.1450	885.0000	-872.0000	1757
4701731177	GAS	5/17/1919	31177	EPC	-80.8064	39.1700	1064.0000	-933.0000	1997
4701773316	UNK		73316	UNKNOWN	-80.7976	39.1517	0.0000	-9999.0000	9999

RECEIVED  
Office of Oil and Gas

DEC 20 2019

WV Department of  
Environmental Protection



EQT Production Company  
400 Woodcliff Drive  
Canonsburg, PA 15317  
[www.eqt.com](http://www.eqt.com)

John Zavatchan  
Project Specialist - Permitting  
O: 724-746-9073  
C: 412-584-3132  
[jzavatchan@eqt.com](mailto:jzavatchan@eqt.com)

December 19, 2019

*Via FedEx Overnight*

West Virginia Department of Environmental Protection  
Office of Oil and Gas  
601 57<sup>th</sup> Street, S.E.  
Charleston, WV 25304

RE: Well Work Permit Modification  
OXF43H34 Well  
Permit Number 47-017-06885  
Southwest/Cove District  
Doddridge County, WV

WVDEP Recipient,

Attached please find the Well Work Permit Modification Application for the well referenced above. Included with this submittal you will find:

- Completed Form WW-6B, approved by the Oil and Gas Inspector
- Wellbore Diagram
- Geologic Prognosis
- Casing Letter
- Site Specific Safety and Environmental Plan
- Well Location Plat
- Completed Form WW-6A1 and supporting documentation
- Department of Highways Certification Letter
- Sheet 1 and 10 of the approved as-built site plans, showing the updated proposed AST locations
- Hydraulic Fracturing Monitoring Plan
- DVD containing the Site Specific Safety and Environmental Plan, Site Plans and MSDS Sheets

Please note that there were no changes to the MSDS sheets from the original permit.

EQT Production trusts that if any portion of the submitted documentation is found to be inadequate for processing the permit, notification will be made to our land department at your earliest convenience. It is EQT Production's intent to cooperate fully to provide any additional requested documentation and clarification in a timely manner such that permitting proceeds in a predictable and logical manner.

Best Regards,

John Zavatchan  
Landman - Permitting  
[jzavatchan@eqt.com](mailto:jzavatchan@eqt.com)  
724-746-9073

RECEIVED  
Office of Oil and Gas

DEC 20 2019

WV Department of  
Environmental Protection

STATE OF WEST VIRGINIA  
DEPARTMENT OF ENVIRONMENTAL PROTECTION, OFFICE OF OIL AND GAS  
WELL WORK PERMIT APPLICATION

1) Well Operator: EQT Production Company 306686 Doddridge Southwest/Cove Oxford  
Operator ID County District Quadrangle

2) Operator's Well Number: OXF43H34 Well Pad Name: OXF43

3) Farm Name/Surface Owner: Cathy Jean Wetzels, et. al. Public Road Access: Rt. 20

4) Elevation, current ground: 1,229' (As-Built) Elevation, proposed post-construction: 1,229' (As-Built)

5) Well Type (a) Gas  Oil \_\_\_\_\_ Underground Storage \_\_\_\_\_

Other \_\_\_\_\_

(b) If Gas Shallow  Deep \_\_\_\_\_

Horizontal

6) Existing Pad: Yes or No Yes

7) Proposed Target Formation(s), Depth(s), Anticipated Thickness and Expected Pressure(s):  
Marcellus, 6,647', 57', 2951 psi

8) Proposed Total Vertical Depth: 6,647'

9) Formation at Total Vertical Depth: Marcellus

10) Proposed Total Measured Depth: 18,157'

11) Proposed Horizontal Leg Length: 10,951'

12) Approximate Fresh Water Strata Depths: 70', 221', 307', 382'

13) Method to Determine Fresh Water Depths: Offset wells: 017-01623, 017-03817, 017-03831, 017-03828, 017-03832

14) Approximate Saltwater Depths: None expected - if encountered will be below 945'

15) Approximate Coal Seam Depths: 321'-322'

16) Approximate Depth to Possible Void (coal mine, karst, other): None Reported

17) Does Proposed well location contain coal seams directly overlying or adjacent to an active mine? Yes \_\_\_\_\_ No

(a) If Yes, provide Mine Info: Name: \_\_\_\_\_  
Depth: \_\_\_\_\_  
Seam: \_\_\_\_\_  
Owner: \_\_\_\_\_



STATE OF WEST VIRGINIA  
DEPARTMENT OF ENVIRONMENTAL PROTECTION, OFFICE OF OIL AND GAS  
WELL WORK PERMIT APPLICATION

1) Well Operator: EQT Production Company 306686 Doddridge Southwest/Cove Oxford  
Operator ID County District Quadrangle

2) Operator's Well Number: OXF43H34 Well Pad Name: OXF43

3) Farm Name/Surface Owner: Cathy Jean Wetzal, et. al. Public Road Access: Rt. 20

4) Elevation, current ground: 1,229' (As-Built) Elevation, proposed post-construction: 1,229' (As-Built)

5) Well Type (a) Gas  Oil \_\_\_\_\_ Underground Storage \_\_\_\_\_

Other \_\_\_\_\_

(b) If Gas Shallow  Deep \_\_\_\_\_

Horizontal

6) Existing Pad: Yes or No Yes

7) Proposed Target Formation(s), Depth(s), Anticipated Thickness and Expected Pressure(s):  
Marcellus, 6,647', 57', 2951 psi

8) Proposed Total Vertical Depth: 6,647'

9) Formation at Total Vertical Depth: Marcellus

10) Proposed Total Measured Depth: 18,157'

11) Proposed Horizontal Leg Length: 10,951'

12) Approximate Fresh Water Strata Depths: 70', 221', 307', 382'

13) Method to Determine Fresh Water Depths: By Offset Wells

14) Approximate Saltwater Depths: N/A

15) Approximate Coal Seam Depths: 321'-322'

16) Approximate Depth to Possible Void (coal mine, karst, other): None Reported

17) Does Proposed well location contain coal seams directly overlying or adjacent to an active mine? Yes \_\_\_\_\_ No

(a) If Yes, provide Mine Info: Name: \_\_\_\_\_  
Depth: \_\_\_\_\_  
Seam: \_\_\_\_\_  
Owner: \_\_\_\_\_

RECEIVED  
Office of Oil and Gas

DEC 20 2019

WV Department of  
Environmental Protection

DAR  
12/16/19

18) CASING AND TUBING PROGRAM

TYPE	Size (in)	New or Used	Grade	Weight per ft. (lb/ft)	FOOTAGE: For Drilling (ft)	INTERVALS: Left in Well (ft)	CEMENT: Fill-up (Cu. Ft.)/CTS
Conductor	26	New	A-500	85.6	40	40	49 ft <sup>3</sup> / CTS
Fresh Water	13 3/8	New	J-55	54.5	532	532	546 ft <sup>3</sup> / CTS
Coal							
Intermediate	9 5/8	New	P-110	40	5272	5272	2087 ft <sup>3</sup> / CTS
Production	5 1/2	New	P-110 CYHP	20	18157	18157	500' above intermediate casing
Tubing	2 3/8		J-55	4.7		May not be run, if run set 40' above top perf or 80° inclination.	
Liners							

TYPE	Size (in)	Wellbore Diameter (in)	Wall Thickness (in)	Burst Pressure (psi)	Anticipated Max. Internal Pressure (psi)	Cement Type	Cement Yield (cu. ft./k)
Conductor	26	30	.312	1050	18	Class A	1.18
Fresh Water	13 3/8	17 1/2	.38	2730	2184	Class A / Type 1	1.13 - 1.19
Coal							
Intermediate	9 5/8	12 3/8	.395	7900	3160	Class A / Type 1	1.13 - 1.19
Production	5 1/2	8 1/2	.361	14360	10112	Class A/H	1.04 - 2.098
Tubing	2 3/8	NA	.19	7700			
Liners							

PACKERS

Kind:				
Sizes:				
Depths Set:				

DAK  
12/16/19

RECEIVED  
Office of Oil and Gas

DEC 20 2019

19) Describe proposed well work, including the drilling and plugging back of any pilot hole:

Drill and complete a new horizontal well in the Marcellus Formation. Drill the vertical to an approximate depth of 1000'. Kick off and drill curve. Drill the lateral in the Marcellus. Cement casing.

20) Describe fracturing/stimulating methods in detail, including anticipated max pressure and max rate:

Hydraulic fracturing is completed in accordance with state regulations using water recycled from previously fractured wells and obtained from freshwater sources. This water is mixed with sand and a small percentage (less than 0.1%) of chemicals (including 15% Hydrochloric acid, friction reducer, biocide, and scale inhibitor), referred to in the industry as a "slickwater" completion. Maximum anticipated internal casing pressure is expected to be approximately 10,000 psi, maximum anticipated treating rates are expected to average approximately 100 bpm. Stage lengths vary from 150 to 300 feet. Average approximately 350,000 gallons of water per stage. Sand sizes vary from 100 mesh to 20/40 mesh. Average approximately 200,000-600,000 pounds of proppant per stage.

21) Total Area to be disturbed, including roads, stockpile area, pits, etc., (acres): N/A - Site Built

22) Area to be disturbed for well pad only, less access road (acres): N/A - Site Built

23) Describe centralizer placement for each casing string:

- Surface: Bow spring centralizers – One centralizer at the shoe and one spaced every 500'.
- Intermediate: Bow spring centralizers– One centralizer at the shoe and one spaced every 500'.
- Production: One solid body centralizer spaced every joint from production casing shoe to KOP

24) Describe all cement additives associated with each cement type:

Conductor: Class A no additives  
Surface: Calcium Chloride. Used to speed the setting of cement slurries  
Intermediate: Calcium Chloride. Used to speed the setting of cement slurries.  
Production: Calcium Carbonate, Fluid Loss, Extender, Dispersent, Viscosifier, Defoamer, POZ, Bonding Agent, Retarder, Anti-Settling/Suspension Agent

25) Proposed borehole conditioning procedures:

Surface: Circulate hole clean while rotating & reciprocating the drill string until cuttings diminish at surface.  
Intermediate: Circulate hole clean while rotating & reciprocating the drill string until cuttings diminish at surface.  
Production: Perform a cleanup cycle by pumping 3-8 bottoms up or until the shakers are clean. Check volume of cuttings coming across the shakers every 15 minutes.

RECEIVED  
Office of Oil and Gas

\*Note: Attach additional sheets as needed.

*DAK*  
*12/10/19*

DEC 20 2019

DEC 20 2019

WV Department of  
Environmental Protection

Well **516243(OXF43H34)**  
EQT Production  
Oxford Quad  
Doddridge County, WV

Azimuth 155  
Vertical Section 11900  
Enertia # 516243(OXF43H34)

Note: Diagram is not to scale

Formations	Top TVD	Base TVD
Conductor	40	
Base Fresh Water	382	
Surface Casing	532	
Base Red Rock	1073	
Maxton	1084 - 1124	
Big Lime	1960 - 2028	
Big Injun	2072 - 2104	
Weir	2246 - 2372	
Gantz	2446 - 2528	
Fifty foot	2528 - 2585	
Thirty foot	2626 - 2662	
Gordon	2668 - 2717	
Forth Sand	2768 - 2835	
Bayard	2948 - 3019	
Warren	3282 - 3348	
Speechley	3348 - 3853	
Balltown A	3853 - 4211	
Riley	4451 - 4827	
Benson	4827 - 4921	
Alexander	5129 - 5222	
Intermediate Casing	5272	
Sonyea	6305 - 6455	
Middlesex	6455 - 6445	
Genesee	6445 - 6554	
Geneseo	6554 - 6596	
Tully	6596 - 6609	
Hamilton	6609 - 6627	
Marcellus	6627 - 6683	
Production Casing	6647	
Onondaga	6683	

Casing and Cementing			Deepest Fresh Water: 382'	
Type	Conductor	Surface	Intermediate	Production
Hole Size, In.	30	17 1/2	12 3/8	8 1/2
Casing Size, OD In.	26	13 3/8	9 5/8	5 1/2
Casing Wall Thickness, In.	0.312	0.380	0.395	0.361
Depth, MD	40'	532'	5,272'	18,157'
Weight	85.6#	54.5#	40#	20#
Grade	A-500	J-55	P-110	P-110 CYHP
New or Used	New	New	New	New
Burst (psi)	1,050	2,730	7,900	14,360
Cement Class	A	A / Type 1	A / Type 1	A / H
Cement Yield	1.18	1.13 - 1.19	1.13 - 1.19	1.04 - 2.098
Top of Cement (Planned)	Surface	Surface	Surface	500' above intermediate casing
Method	Displacement	Displacement	Displacement	Displacement
Est. Volume (cu ft)	49	546	2,087	4,071
Possible Additives	N/A	Calcium Chloride	Calcium Chloride	Calcium Carbonate, Fluid Loss, Extender, Dispersant, Viscosifier, Defoamer, POZ, Bonding Agent, Retarder, Anti-Settling/Suspension Agent

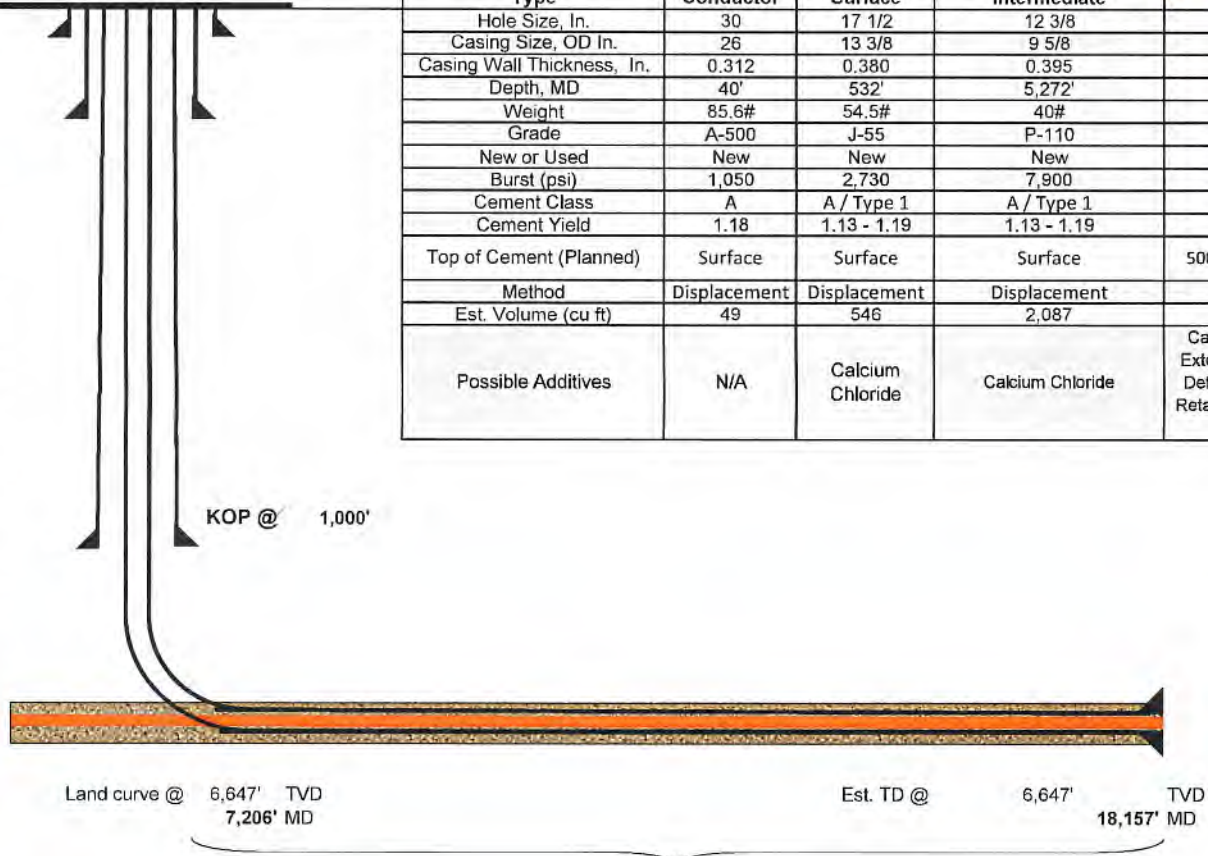

Proposed Well Work:  
Drill and complete a new horizontal well in the Marcellus formation.  
Drill the vertical to an approximate depth of 1000'.  
Kick off and drill curve. Drill lateral in the Marcellus. Cement casing.

10,951' Lateral

**WEST VIRGINIA GEOLOGICAL PROGNOSIS**

Horizontal Well  
OXF43H30

516238(OXF43H30)

**Drilling Objectives:** Marcellus  
**County:** Doddridge  
**Quad:** Oxford  
**Elevation:** 1242 KB 1229 GL (As-Built)  
**Surface location** Northing: 241902.39 Easting: 1633402.15  
**Landing Point** Northing: 241820.78 Easting: 1629095.40  
**Toe location** Northing: 250051.23 Easting: 1625527.70  
**Recommended Azimuth** 0 Degrees

TVD: 6647  
 Recommended LP to TD: 0,000'

**Recommended Gas Tests:** 1800, 2050, 2600, Intm Csg. Pt., 3400, 4900, 5250, KOP, (Gas test at any mine void)  
 Gas test during any trip or significant downtime while drilling the lateral section.

**ESTIMATED FORMATION TOPS**

Determined from OXF43 and OXF45 Pilot Hole Logs

Formation	Top (TVD)	Base (TVD)	Lithology	Comments	Top RR	Base RR
Fresh Water Zone	1	382		FW @ 70,221,307,382, ,	21	41
Waynesburg A	321	322	Coal	No past, present, or permitted mining.	123	179
Maxton	1084	1124	Sandstone	No SW present in shallow offset wells.	181	211
Big Lime	1960	2028	Limestone		266	411
Big Injun	2072	2104	Sandstone	Storage is NOT of concern at this location	361	451
Weir	2246	2372	Sandstone		462	532
Top Devonian	2446				561	716
Gantz	2446	2528	Silty Sand		706	829
Fifty foot	2528	2585	Silty Sand		956	1073
Thirty foot	2626	2662	Silty Sand			Base of Red Rock
Gordon	2668	2717	Silty Sand			
Forth Sand	2768	2835	Silty Sand			
Bayard	2948	3019	Silty Sand			
Warren	3282	3348	Silty Sand			
Speechley	3348	3853	Silty Sand			
Balltown A	3853	4211	Silty Sand			
Riley	4451	4827	Silty Sand			
Benson	4827	4921	Silty Sand			
Alexander	5129	5222	Silty Sand	Base of Offset Well Perforations at 5207' TVD		
Int. csg pt	5272					
Elks	5222	6305	Gray Shales and Silts			
Sonyea	6305	6455	Gray shale			
Middlesex	6455	6445	Shale			
Genesee	6445	6554	Gray shale interbedded			
Genesee	6554	6596	Black Shale			
Tully	6596	6609	Limestone			
Hamilton	6609	6627	Gray shale with some			
Marcellus	6627	6683	Black Shale			
Purcell	6658	6661	Limestone			
-Lateral Zone	6647			Start Lateral at 6647'		
Cherry Valley	6667	6670	Limestone			
Onondaga	6683		Limestone			

Target Thickness	57 feet
Max Anticipated Rock Pressure	2951 PSI

**Comments:**

Note that this is a TVD prog for a horizontal well (azimuth of 0 degrees; target formation = Marcellus). All measurements taken from estimated KB elevation. Water and coal information estimated from surrounding well data.  
 Intermediate casing point is recommended 50' beneath the Alexander to shut off any water production from the Upper Devonian sands. Intermediate casing should be cemented into the surface string, per WV regulations.  
 The estimated landing point TVD is 6647', rig geologist may adjust landing point. After the well is landed, drill to reported bed dips/geologists' recommendation. The geologic structure is unknown at this time.

**RECOMMENDED CASING POINTS**

<b>Fresh Water/Coal</b>	CSG OD	13 3/8	CSG DEPTH:	532	150' below freshwater
<b>Intermediate 1:</b>	CSG OD	9 5/8	CSG DEPTH:	5272	50' below Alexander
<b>Production:</b>	CSG OD	5 1/2	CSG DEPTH:	@ TD	

RECEIVED  
Office of Oil and Gas

30 2019

WV Department of  
Environmental Protection



December 11, 2019

Mr. Taylor Brewer  
West Virginia Department of Environmental Protection  
Office of Oil and Gas  
601 57th Street SE  
Charleston, WV 25304

Re: Casing on OXF43H34

Dear Mr. Brewer,

The 13-3/8" surface casing will be set at 532' KB, 150' below the deepest fresh water. The 9-5/8" intermediate string will be set at 5,272' KB, 50' below the base of the Alexander formation.

If you have any questions, please do not hesitate to contact me at 724-746-9073.

Sincerely,

A handwritten signature in blue ink, appearing to read 'J. Zavatchan'.

John Zavatchan  
Landman - Permitting

Enc.

RECEIVED  
Office of Oil and Gas

DEC 20 2019

WV Department of  
Environmental Protection



Where energy meets innovation.™

# Site Specific Safety and Environmental Plan

EQT

OXF43 Pad

West Union

Doddridge County, WV

For Wells:

<u>516228</u>	<u>516229</u>	<u>516230</u>	<u>516231</u>	<u>516232</u>	<u>516233</u>	<u>516234</u>
<u>516235</u>	<u>516238</u>	<u>516240</u>	<u>OXF43H32</u>	<u>OXF43H34</u>	<u>OXF43H35</u>	<u>          </u>

Date Prepared: February 18, 2019

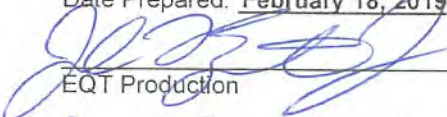
  
EQT Production

PROJECT SPECIALIST - PERMITTING  
Title

12-11-19  
Date

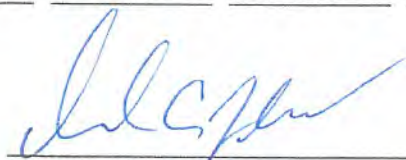

WV Oil and Gas Inspector

Oil & Gas Inspector  
Title

12/16/19  
Date

RECEIVED  
Office of Oil and Gas

FEB 20 2019

WV Department of  
Environmental Protection

THIS PAGE INTENTIONALLY LEFT BLANK

RECEIVED  
Office of Oil and Gas

SEP 20 2019

WV Department of  
Environmental Protection



# TABLE OF CONTENTS

Section	Description	Page
	Document Title Page.....	1
	Table of Contents .....	3
	Record of Revision and Change .....	5
I	Contacts, Schedules, & Meetings .....	7
II	Maps & Diagrams .....	14
III	Well Work: Marcellus & Utica Regions.....	15
IV	Chemical Inventory & SDS .....	20
V	BOP & Well Control for Marcellus & Utica Regions .....	21
VI	Hydrogen Sulfide .....	26
VII	Flaring .....	26
XIII	Collision Avoidance .....	28
IX	Deep Well Additional Requirements .....	29
X	Well Site Safety Plan Receipt Acknowledgement .....	32

**Attachments**

- Response Guides**
- EQT Preparedness, Prevention and Contingency Plan**
- EQT Control and Disposal Plan**
- EQT Containment Plan**
- EQT Training Log**
- EQT Tailgate Safety Meeting Form**
- EQT Phone Threat Response Form**
- Hydrogen Sulfide (H<sub>2</sub>S) Plan**
- LNG/CNG Trailer Unload Operations**

RECEIVED  
Office of Oil and Gas

 DEC 20 2019

This Page Left Intentionally Blank

RECEIVED  
Office of Oil and Gas

DEC 20 2019

WV Department of  
Environmental Protection

<b>Site Specific Emergency Action Plan</b>		
<b><u>Rev #</u></b>	<b><u>Rev Date</u></b>	<b><u>Rev Changes</u></b>
000	2/21/2018	Original
001	12/21/2018	Pg. 5: Change Plan Administrator Pg. 5: Change Final Approver Title Pg. 5: Remove Assistant Plan Administrator Pg. 7: Change Government Relations point of contact Pg. 22: Section III PPE. ADD protective glove requirement Pg. 22: Section III PPE. ADD specialty glove requirement Pg. 25: Section III ADD Plugging Operations Pg. 28: Section III ADD Plugging Operations
002	02/18/2019	Pg. 5: Change Plan Administrator Pg. 5: Change Approver Pg. 5: Change Final Approver Pg. 5: Remove Assistant Plan Administrator Pg. 7: Change EQT Environmental Contact
Plan Administrator: Scott M. Held Senior Safety Coordinator		Approval: Joseph Smetanka Director, Corporate Safety
		Final Approver: Charity Fleenor Director, Environmental Affairs

RECEIVED  
Office of Oil and Gas

DEC 20 2019

WV Department of  
Environmental Protection

This Page Left Intentionally Blank

RECEIVED  
Office of Oil and Gas

DEC 20 2019

WV Department of  
Environmental Protection

**Section I: Contacts, Schedules and Meetings**

<b>EMERGENCY SERVICES</b>	
<b><u>County Emergency Dispatch Center</u></b>	<b>PHONE NUMBER</b>
<b>Doddridge County 911</b>	<b>EMERGENCY 9-1-1</b>
- For Police, Fire, Ambulance	<b>10-digit: 304-659-3770</b>
<b><u>County Emergency Services/ Management (CES)</u></b>	
Doddridge County Office of Emergency Management 108 Court Street, Suite 1 West Union, WV 26456 Director: George C. Eidel	<b>10-digit: 304-873-3253</b>  Office: 304-281-7407 (cell)
<b><u>Nearest Hospital</u></b>	<b>ER Phone Number</b>
United Hospital Center of Bridgeport 327 Medical Park Dr. Clarksburg, WV 26330 Distance: 48.7 miles Travel Time: 1 hr 12 mins	<b>10-digit: 681-342-1000</b>
<b>SEE ATTACHED MAP</b>	

<b>EQT EMERGENCY CONTACTS</b>	
<b>EQT 24-Hour</b>	<b>1-800-926-1759</b>
EQT Environmental - Kim Gissy	C: 304-627-8347
EQT Health and Safety Department - Brian O'Neil	O: 724-743-4688 C: 412-463-6430
EQT Government and Community Relations Local Government - Joseph Dawley	O: 412-553-7708
EQT State Government, WV Government Relations Manager - Gregory Hoyer	O: 304-348-3886 C: 304-546-1923

RECEIVED  
Office of Oil and Gas

DEC 20 2019

WV Department of  
Environmental Protection

<b>OTHER EMERGENCY CONTACTS</b>	
WVDEP Office of Oil & Gas – <b>Pollution &amp; Emergency Spills</b>	<b>1-800-642-3074</b>
Local State Well Inspector: Daniel Fleck	304-545-0109 (cell)
USCG/National Response Center (NRC)	800-424-8802
CHEMTREC	<b>Emergency 800-424-9300</b> Business: 800-262-8200
US DOT Pipeline & Hazardous Materials Safety Administration (PHMSA)	Pipeline: 202-366-4595 HazMat: 800-467-4922

**Notification Methods**

Notification of the public will be made in conjunction with EQT personnel listed above and emergency first responders listed above in the event that they are affected by an event such as hydrogen sulfide releases, blow-outs and flaring. The public list is attached to the map listed in Section II: Maps and Diagrams and the procedures for notification, isolation zones, and evacuations are also listed in Section II: Maps and Diagrams.

Flaring notification procedures are listed in Section V: BOP and Well Control.

Additional actions and precautions for the presence of hydrogen sulfide are listed in Section VI: Hydrogen Sulfide.

**Pre-Drill Meeting**

A Pre-Drill Meeting will be held on location with the following personnel in attendance:

- WV OOG Inspector and /or Supervisor
- EQT Land Agent
- EQT Construction Specialist
- EQT Drilling Contractor Personnel, i.e. Tool Pusher, Driller(s), Safety Manager
- EQT On-Site Drilling Specialist and/or Supervisor

Optional attendees may include:

- EQT Safety and Health Coordinator or designee, if available
- EQT Environmental Coordinator or designee, if available
- EQT H2S Contractor representative, if in an H2S plan required zone.
- EQT Completions Personnel

RECEIVED  
Office of Oil and Gas

DEC 20 2019

WV Department of  
Environmental Protection



Upper Run, Pullman, WV 26421 to United Hospital Center, Bridgeport, WV

Drive 48.7 miles, 1 h 12 min

WV Doddridge OXF43 Well Pad Hospital Directions

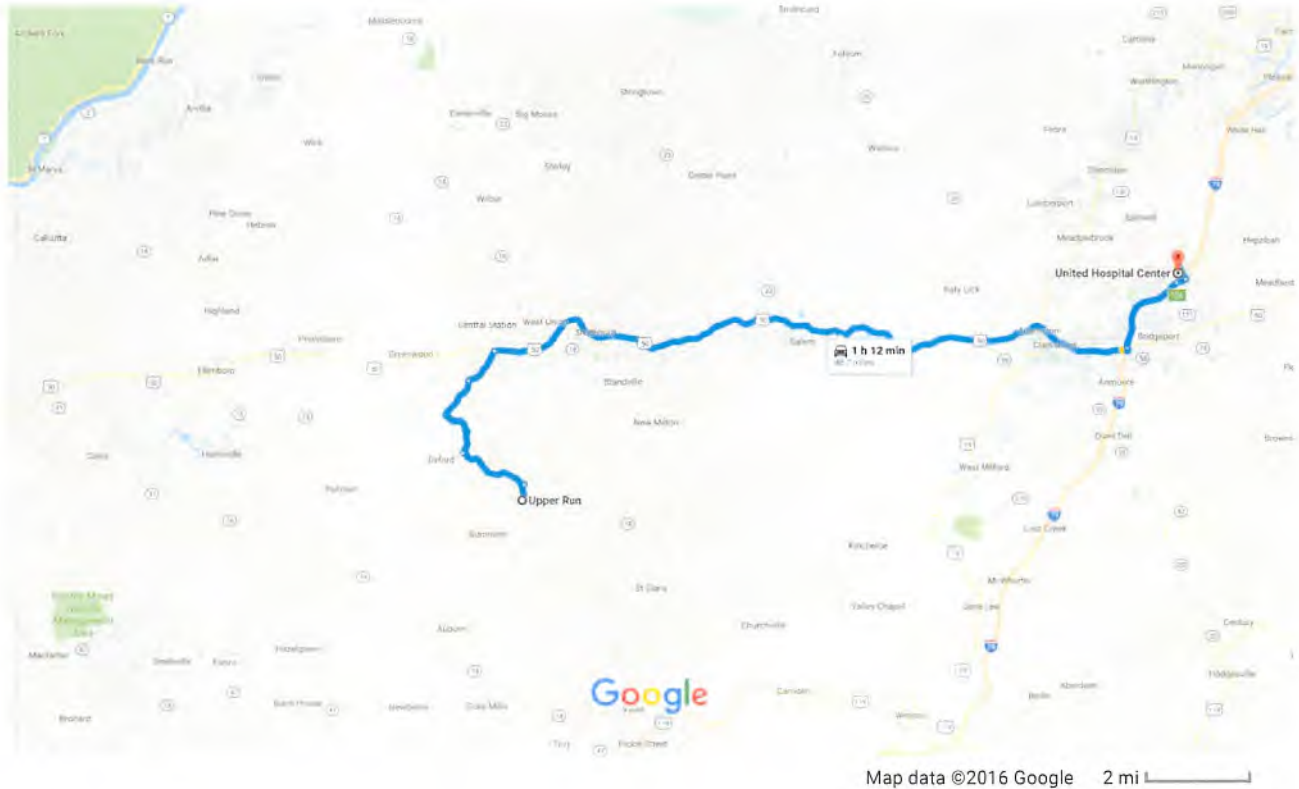

### Upper Run

Pullman, WV 26421

Take S Fork of Hughes River and Co Rte 21 to US-50 E in Pine

30 min (10.7 mi)

- ↑ 1. Head northeast on Upper Run toward S Fork of Hughes River 0.8 mi
- ↶ 2. Turn left onto S Fork of Hughes River 3.5 mi
- ↷ 3. Turn right onto Co Rte 21 4.5 mi
- ↷ 4. Turn right onto Old U.S 50 W/Sunnyside Rd 1.9 mi

Continue on US-50 E to Bridgeport. Take exit 124 from I-79 N



37 min (36.9 mi)

- ↷ 5. Turn right onto US-50 E 31.9 mi

RECEIVED  
Office of Oil and Gas

DEC 20 2019

WV Department of

-  6. Use the right lane to merge onto I-79 N via the ramp to Fairmont 4.6 mi
-  7. Take exit 124 for WV-279 toward US-50 E/Jerry Dove Dr 0.4 mi

**Continue on WV-279 W to your destination**

-  8. Turn left onto WV-279 W 3 min (1.1 mi)
-  9. Turn left at White Oaks Blvd 0.7 mi
-  10. Continue onto Medical Park Dr 0.2 mi
-  11. Turn left 351 ft
  -  Destination will be on the left 0.1 mi

## United Hospital Center

These directions are for planning purposes only. You may find that construction projects, traffic, weather, or other events may cause conditions to differ from the map results, and you should plan your route accordingly. You must obey all signs or notices regarding your route.

RECEIVED  
Office of Oil and Gas

DEC 20 2019

WV Department of  
Environmental Protection



## **Safety Meetings**

A completed and documented EQT Tailgate Safety Meeting (TSM) or Contractor Representative Tailgate Talk or Job Safety Analysis (JSA) is required prior to the beginning of each work shift during all phases of the operation. Copies of these forms should be logged and kept in a location on-site for periodic auditing by EQT or the contractor.

*See the attached EQT Tailgate Safety Meeting (TSM) Form on the following pages.*

RECEIVED  
Office of Oil and Gas

DEC 20 2019

WV Department of  
Environmental Protection

**EQT Tailgate Safety Meeting**

**Section 1: General Information**

Date & Time: \_\_\_\_\_ Location/Physical Address: \_\_\_\_\_  
 Project Name: \_\_\_\_\_ GPS Coordinates: \_\_\_\_\_  
 Emergency Contact: \_\_\_\_\_ Emergency Notification #: \_\_\_\_\_  
**DIAL 911 FOR ALL EMERGENCIES - IF 911 IS NOT AVAILABLE, LIST AN ALTERNATIVE NUMBER:** \_\_\_\_\_  
 Primary Assembly Point: \_\_\_\_\_ Secondary Assembly Point: \_\_\_\_\_  
 Nearest Medical Facility: \_\_\_\_\_ Nearest Fire Extinguisher: \_\_\_\_\_  
 Nearest First Aid Kit: \_\_\_\_\_ Nearest Eye Wash: \_\_\_\_\_  
 Do Cell Phones Work:  Yes  No Project Name: \_\_\_\_\_  
 Are other personnel on-site conducting tasks not related to this task?  Yes  No  
 If you answered YES to the question above, will the other personnel be affected by this task?  YES  NO  
 If you answered YES to the question above, have you included those personnel in this TSM?  YES  NO

**Section 2: Task Information**

Describe the task to be performed: \_\_\_\_\_  
 \_\_\_\_\_  
 \_\_\_\_\_  
 Are the employees working on a task out of sight of each other? If so, what communication method is being used?  Cell Phone  Land Line  2-Way Radio  Other

**Section 3: Hazard Identification & Control**

Type of Work:  Hot Work  Lockout/Tagout  Excavation  Confined Space (If checked, additional permits/forms must be completed)

**Mark An X On All Applicable Hazards For This Task:**

<input type="checkbox"/> Hazardous Atmosphere	<input type="checkbox"/> Overhead Hazards	<input type="checkbox"/> Hydrates/Line Blockage	<input type="checkbox"/> Radiation
<input type="checkbox"/> Temperature Extremes (Heat & Cold)	<input type="checkbox"/> Chemical Exposure	<input type="checkbox"/> Lifting (Sprains & Strains)	<input type="checkbox"/> Asbestos/Lead Materials
<input type="checkbox"/> Safety Systems Bypassed/Disabled	<input type="checkbox"/> Weather Hazards	<input type="checkbox"/> Condensate/Flammability	<input type="checkbox"/> PCBs
<input type="checkbox"/> Trapped Pressure	<input type="checkbox"/> Heavy Loads	<input type="checkbox"/> Slips/Trips/Falls (Alternate Route)	<input type="checkbox"/> Dusty Environment
<input type="checkbox"/> Fall From Heights	<input type="checkbox"/> Noise	<input type="checkbox"/> Excavation Collapse	<input type="checkbox"/> Roadway Work (Traffic Control)
<input type="checkbox"/> Moving Machinery	<input type="checkbox"/> Electrical	<input type="checkbox"/> Adjacent Operations	<input type="checkbox"/> Wildlife (Snakes, Bears, etc.)
<input type="checkbox"/> Suspended Loads/Rigging	<input type="checkbox"/> Pinch Points	<input type="checkbox"/> Mobile Equipment	<input type="checkbox"/> Insects (Bees, Ticks, etc.)
<input type="checkbox"/> Ignition Sources	<input type="checkbox"/> Lone Worker	<input type="checkbox"/> Overexertion	<input type="checkbox"/> Poison Oak, Ivy, Sumac
			<input type="checkbox"/> Other _____

Describe location driving hazards (well heads, barriers, tanks, low hanging tree limbs, etc.) and parking location. \_\_\_\_\_  
 \_\_\_\_\_

**Section 4: Personal Protective Equipment**

Mark An X Next To Required PPE: **HARD HAT, SAFETY GLASSES AND HARD TOE BOOTS ARE ALWAYS REQUIRED**

GENERAL PPE		GLOVES	Fall Arrest	Personal Monitors	RESPIRATOR TYPE*
<input type="checkbox"/> Face Shield	<input type="checkbox"/> General Purpose	<input type="checkbox"/> General Purpose	<input type="checkbox"/> Harness	<input type="checkbox"/> 4-Gas Monitor	<input type="checkbox"/> Dust Mask
<input type="checkbox"/> FR Clothing	<input type="checkbox"/> Chemical Resistant	<input type="checkbox"/> Chemical Resistant	<input type="checkbox"/> Lanyard	<input type="checkbox"/> H <sub>2</sub> S	<input type="checkbox"/> ½ Mask APR
<input type="checkbox"/> Hearing Protection	<input type="checkbox"/> Heat Resistant	<input type="checkbox"/> Heat Resistant	<input type="checkbox"/> Retrieval Line	<input type="checkbox"/> O <sub>2</sub>	<input type="checkbox"/> SCBA
<input type="checkbox"/> Chainsaw Chaps	<input type="checkbox"/> Other	<input type="checkbox"/> Other	<input type="checkbox"/> Other	<input type="checkbox"/> LEL	<input type="checkbox"/> Other
<input type="checkbox"/> Other _____	<input type="checkbox"/> Snake Chaps				

\*Note: (Employees/Contractors must be medically qualified and trained in order to wear a respirator)

**Section 5: TSM Completion**

EQT TSM Leader: Print: \_\_\_\_\_ Signature: \_\_\_\_\_  
 List EQT Employees conducting the tasks and participating in the TSM: (Attach a separate page if additional space is needed or use back of sheet)  
 Print: \_\_\_\_\_ Print: \_\_\_\_\_ Print: \_\_\_\_\_  
 Print: \_\_\_\_\_ Print: \_\_\_\_\_ Print: \_\_\_\_\_  
 Contractor Name (if applicable): \_\_\_\_\_  
 List all contract employees conducting the task: (Attach a separate page if additional space is needed or use back of sheet)  
 Print: \_\_\_\_\_ Print: \_\_\_\_\_ Print: \_\_\_\_\_  
 Print: \_\_\_\_\_ Print: \_\_\_\_\_ Print: \_\_\_\_\_  
 Note: All personnel arriving after initial TSM shall be tailgated: (Attach a separate page if additional space is needed or use back of sheet)  
 Comments: \_\_\_\_\_  
 \_\_\_\_\_

RECEIVED  
 Office of Oil and Gas  
 DEC 20 2019

Department of

**EQT Tailgate Safety Meeting**

List EQT Employees conducting the tasks and participating in the TSM:

Print: _____	Print: _____	Print: _____
Print: _____	Print: _____	Print: _____
Print: _____	Print: _____	Print: _____
Print: _____	Print: _____	Print: _____
Print: _____	Print: _____	Print: _____
Print: _____	Print: _____	Print: _____
Print: _____	Print: _____	Print: _____
Print: _____	Print: _____	Print: _____
Print: _____	Print: _____	Print: _____
Print: _____	Print: _____	Print: _____
Print: _____	Print: _____	Print: _____
Print: _____	Print: _____	Print: _____
Print: _____	Print: _____	Print: _____
Print: _____	Print: _____	Print: _____
Print: _____	Print: _____	Print: _____

Contractor Name (if Applicable): \_\_\_\_\_

List contract employees conducting the task and participating in TSM:

Print: _____	Print: _____	Print: _____
Print: _____	Print: _____	Print: _____
Print: _____	Print: _____	Print: _____
Print: _____	Print: _____	Print: _____
Print: _____	Print: _____	Print: _____
Print: _____	Print: _____	Print: _____
Print: _____	Print: _____	Print: _____
Print: _____	Print: _____	Print: _____
Print: _____	Print: _____	Print: _____
Print: _____	Print: _____	Print: _____
Print: _____	Print: _____	Print: _____
Print: _____	Print: _____	Print: _____
Print: _____	Print: _____	Print: _____
Print: _____	Print: _____	Print: _____
Print: _____	Print: _____	Print: _____

RECEIVED  
Office of Oil and Gas

Note: Retain document for 2 years

DEC 20 2019

## Section II: Maps and Diagrams

### **General Information Pertaining to well pad location:**

WV – Doddridge – West Union

Site State, County and Municipality

EQT OXF43 Pad

Site Location Designation

3731 Grove Summers Rd. West Union, WV 26456

Site Address assigned by County 9-1-1

S Fork of Hughes River

Nearest cross road(s)

39.180296, -80.797064

Access Road Coordinates

39.157175, -80.792576

Pad Site Coordinates

### **Directions:**

***SEE ATTACHED EQT Traffic Control Plan*** Reference use only. See current EQT Traffic Control Plan for updated directions and restrictions.

### **Maps:**

Maps are included on the following pages for reference for the above described well location. The two types of maps included are:

1. Plan View Map
2. Topographical map with 1-mile safety radius

### **Site Evacuation Plan:**

#### **Assembly areas:**

- Each Site is responsible for identifying a designated assembly area for personnel to safely evacuate to in the event of an emergency.
- Evacuation in place may be most suitable for inclement weather but that decision shall be made by the On-Site Specialist or Emergency Coordinator (Examples: Near the access road, Site Location Sign, On-Site Specialist trailer).
- Assembly points should be determined so as to be upwind in consideration of the prevailing wind at the site.
- At a minimum, a secondary assembly area shall be determined. Secondary assembly points should be located to be 90 degrees to the prevailing wind.
- Each determined assembly area shall be communicated to all personnel on the site.

#### **Affected and Unaffected areas:**

- The Emergency Coordinator, or their representative, will establish the emergency area as the affected area and order the evacuation of all non-essential personnel to the primary assembly area.
- The purpose is to minimize the risk of exposure to all personnel.
- On-site rescuers and equipment should be staged in areas unaffected by the emergency.

Off-site services and equipment summoned to the scene should be staged in areas unaffected by the emergency.

Only essential personnel, as determined by the Emergency Coordinator, shall be granted entry into the affected area(s) after an emergency has occurred.

**Evacuation:**

- In the event of an emergency all non-essential personnel shall immediately evacuate their work areas and report to the Assembly Area.
- Evacuation must be quick as life safety may be of the essence.
- Personnel should evacuate to the assembly area via the quickest route. If that route is blocked or hazardous, another route should be taken.
- Personnel should make sure that their co-workers heard the call for evacuation and assure that no one is left behind.
- Only essential personnel required for process critical jobs can stay behind, all others shall evacuate. This decision shall be at the sole discretion of the Emergency Coordinator and in no means should life safety be jeopardized.
- Should the primary assembly area be unsuitable for evacuation, the alternate location shall be communicated to all personnel. The Emergency Coordinator or their designee is responsible for determining the safest assembly area.
- Accountability shall be verified as soon as possible by the Emergency Coordinator or their designee. Those who are unaccounted for shall be immediately reported to the Emergency Coordinator
- If evacuation is required for the surrounding areas, notifications to all personnel listed on the attached Topographical and One-Mile Safety Buffer Map and contact list shall be made by the On-Site Emergency Coordinator or their designee with the assistance of the emergency first responders and the county LEPC or CES.
- Evacuation locations and assembly areas will be made with the coordination of local emergency first responders.

**Scene Access:**

- Access to the scene should be controlled at all times by the Emergency Coordinator or their representative.
- Access needs to be controlled to reduce life safety concerns as well as preserve evidence for investigation and root cause analysis.
- Access should never be restricted in a way as to impede those who are evacuating in an emergency.
- The scene needs to be secured to prevent unauthorized entry by posting signs, tape, personnel, or other means at any and all access points.
- Unauthorized access into the affected area(s) is prohibited and calls for immediate removal from the site.

**Accountability:**

- The daily TSM or JSA shall be used to verify accountability for all personnel as soon as possible after an incident has occurred.
- A sign in and out sheet shall be used to account for personnel entering and exiting the area after an incident has occurred.
- All personnel unaccounted for shall be immediately reported to the Emergency Coordinator as well as emergency first responders.

RECEIVED  
Office of Oil and Gas

 DEC 20 2019

WV Department of  
Environmental Protection

**Plan View (Aerial) Map:**

See the attached West Virginia Rec Plans on the following pages for each well number listed on the permit cover page.

**Plan View map notes:**

This is a basic map of the site which shows the access road(s), nearby dwellings, and true north direction.

The prevailing wind direction for this area is from the southwest unless otherwise noted. Flare lines, if needed, will be run and installed as per procedure.

**Topographical map with 1-mile safety radius**

See the attached topographical map on the following pages along with the attached list with emergency contact information.

**Topographical map with 1-mile safety radius map notes:**

This is a basic map of the site which shows the topography of the area.

A defined 1-mile safety radius is shown on the map along with an attached list, if available, of the names, addresses and telephone numbers of residents, churches, schools and emergency facilities located within that one mile radius.

The map shows the nearby public route numbers and/or names

RECEIVED  
Office of Oil and Gas

DEC 20 2019

DEC 20 2019

WV Department of

# CONSTRUCTION AND RECLAMATION PLAN

## OXF-43 WELL PAD

DODDRIEGE COUNTY, WV

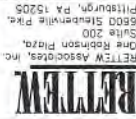

SCALE: AS NOTED  
DATE: 4/27/18  
DRAWN BY: DAW

APPROPRIATE EROSION CONTROL BARRIERS ARE TO BE CONSTRUCTED AT ALL CULVERT AND CROSS DRAIN INLETS AND OUTLETS AS REQUIRED IN THE WDEP OIL AND GAS BMP MANUAL. FIELD CONDITIONS (ROCK OUTCROPS AND BEDROCK) MAY PROHIBIT TRAPS BEING INSTALLED. WHEN THESE CONDITIONS EXIST ADDITIONAL EROSION CONTROL MEASURES SHALL BE EVALUATED AND UTILIZED AS NEEDED.

EARLY WORK CONTRACTORS ARE RESPONSIBLE FOR NOTIFICATION TO THE OPERATOR AND INSPECTOR PRIOR TO ANY DEVIATION FROM THIS PLAN.

TEMPORARY SEED AND MULCH ALL SLOPES AFTER CONSTRUCTION OF LOCATION.

CUT AND STACK ALL MARKETABLE TIMBER.

STACKED BRUSH MAY BE USED FOR SEDIMENT CONTROL.

ACCESS ROAD STREAM CROSSINGS HAVE BEEN PREPARED (IF APPLIES).

= AS-BUILT CULVERT 18" MIN UNLESS OTHERWISE NOTED  
= EXISTING CULVERT  
= APPROXIMATE LIMIT OF DISTURBANCE

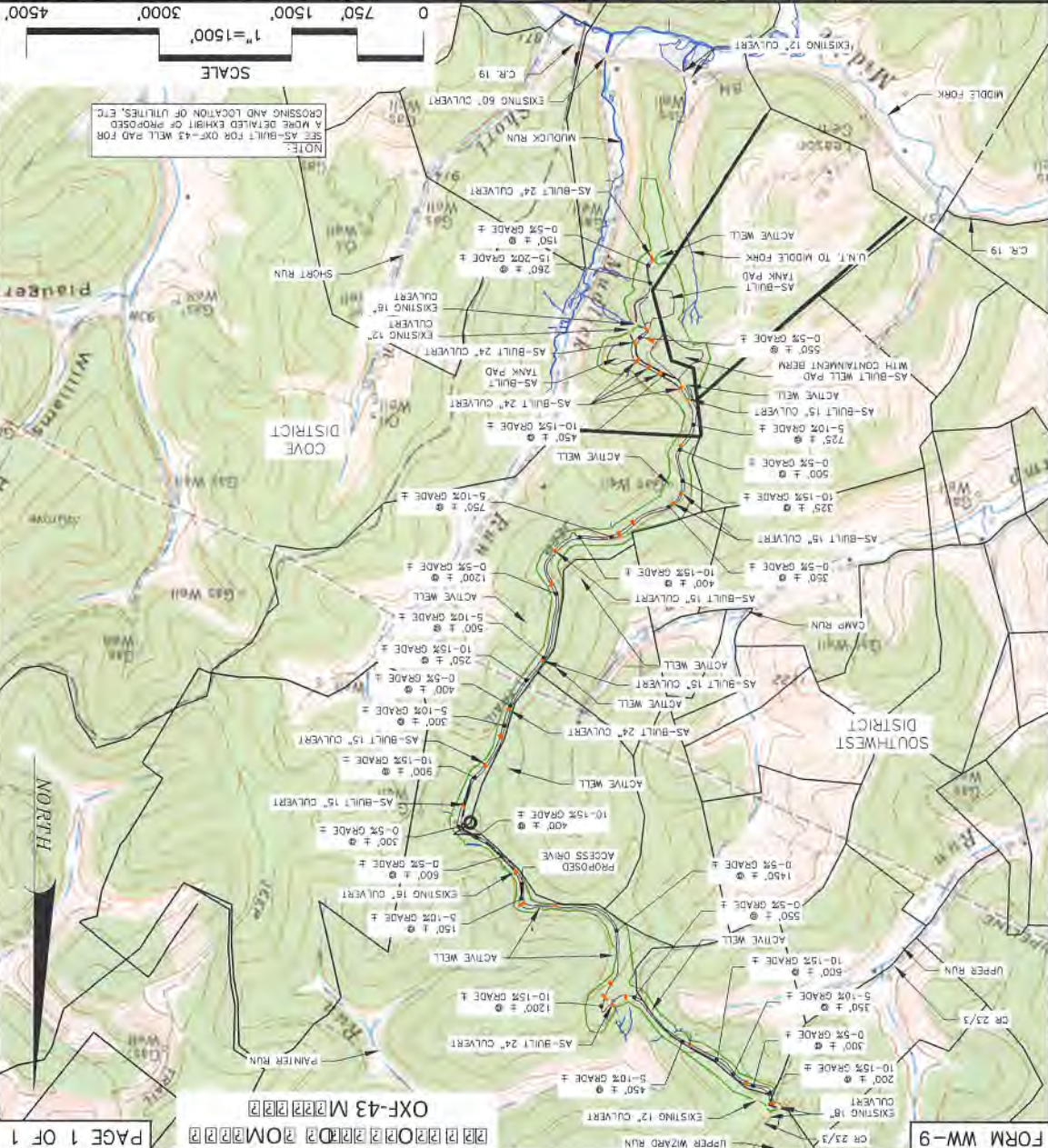
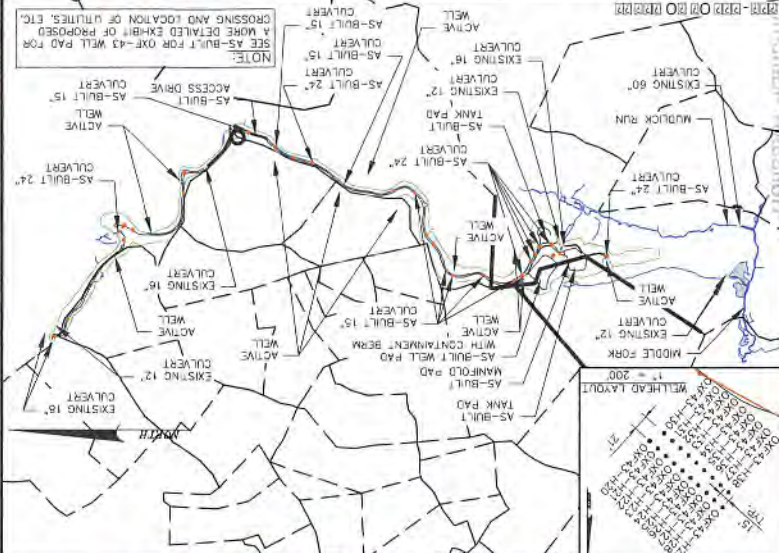

# TRAFFIC CONTROL CHECKLIST



## SELECT SITE

Oxford 43

## SITE INFORMATION

State	WV
County	Doddridge
Township	
School District	Doddridge County
CB Channel	TBD

## DIRECTIONS

Continue on US Rt. 50 West and go 31.8 miles - Turn left onto Sunnyside Road (Rt. 50/30) and go 1.9 miles - Turn left onto Oxford Road (Rt. 21) and go 4.5 miles - Turn left onto S. Fork of Hughes River (Rt. 19/11) and go 3.5 miles - Turn right onto Upper Run Road (Rt. 22/3) and go to 0.8 mile to the beginning of proposed access road on the left with coordinates of 39.18032/-80.79694 - Continue south, along the ridge (some of which is existing access) for 2.4 miles to the OXF-43 Well Site with coordinates of 39.15518/-80.79214

## ACCESS ROAD COORDINATES

39.14828                      -80.79399

## CHECKLIST

### AFFECTED ROADS

Hughes River Road (CR 19/11) (speed limit only, no bus curfew)  
Sunnyside Road (CR 50/30), Oxford Road, Upper Run Rd,



RECEIVED  
Office of Oil and Gas

REC 20 2019

WV Department of  
Environmental Protection



SPEED LIMIT

20 MPH

BUS AM CURFEW BEGINS

6:30:00 AM

BUS AM CURFEW ENDS

7:30:00 AM

BUS PM CURFEW BEGINS

3:15:00 PM

BUS PM CURFEW ENDS

4:30:00 PM

SCHOOL START DATE

8/14/2017

SCHOOL END DATE

---

**CHECK LIST COMPLETED**

Submitted by (DRIVER)

Date

RECEIVED  
Office of Oil and Gas

NOV 14 2019

WV Department of  
Environmental Protection



EQT Corporation  
625 Liberty Ave.  
Pittsburgh, PA 15222

**Legend**

RECEIVED  
Office of Oil and Gas  
DEC 20 2019  
WV Department of  
Environmental Protection



Source: Esri, DigitalGlobe, GeoEye, Earthstar Geographics, CNES/Airbus DS, USDA, USGS, AeroGRID, IGN, and the GIS User Community

Title: OXF43



Disclaimer: This map is confidential and is to be used only for the express informational purposes for which it was created. Unauthorized use, copying, or dissemination is strictly prohibited. EQT does not warrant the accuracy of the location of any items shown on this map, including, but not limited to, any structures, well or pipeline facilities, property boundaries, topography, roadways, or waterways. The items shown on the map may not have been placed on the map using survey lines or GPS coordinates. The specific location of any of the map items should be determined by a field survey performed by a licensed surveyor upon consultation with EQT.

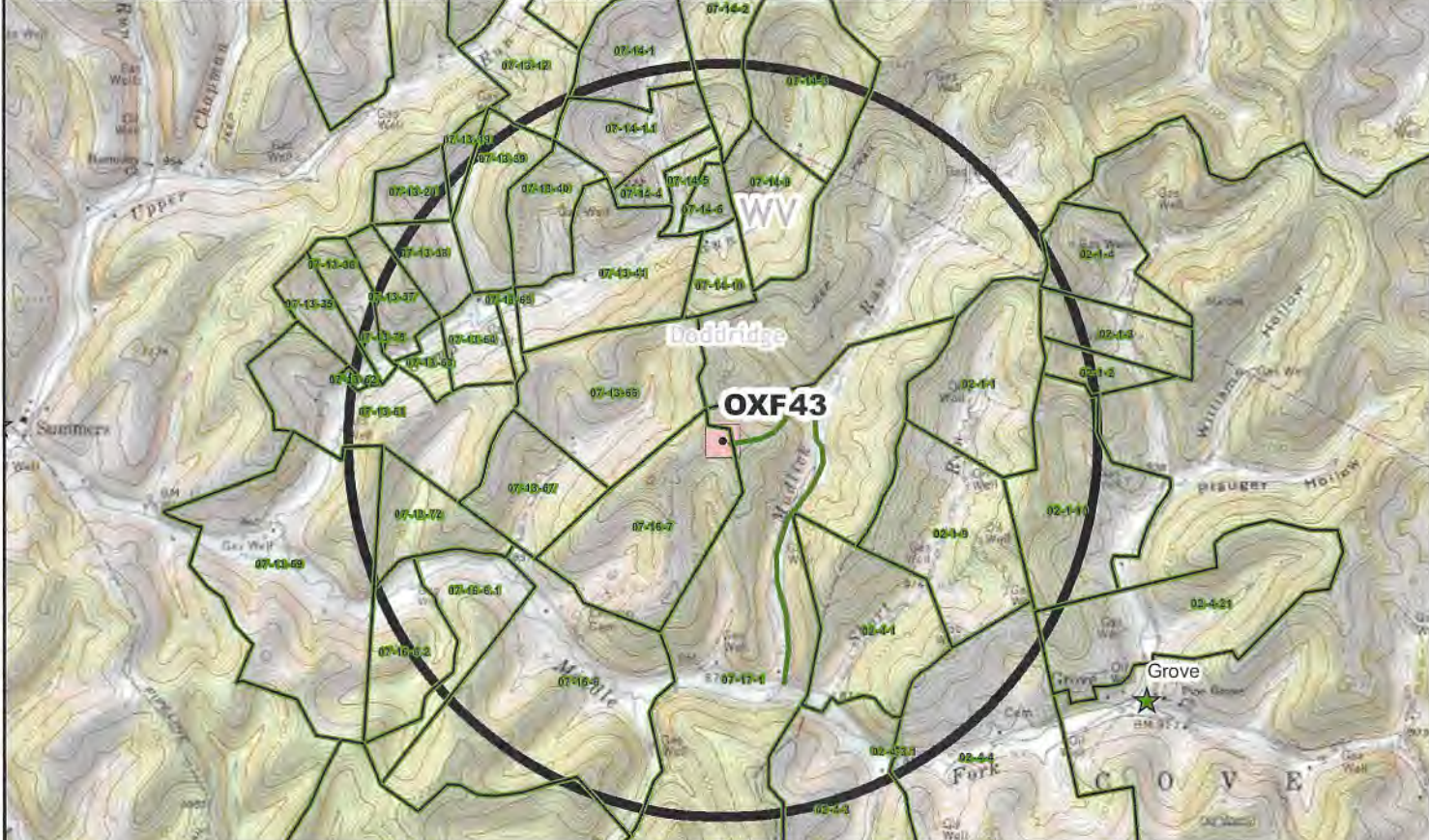
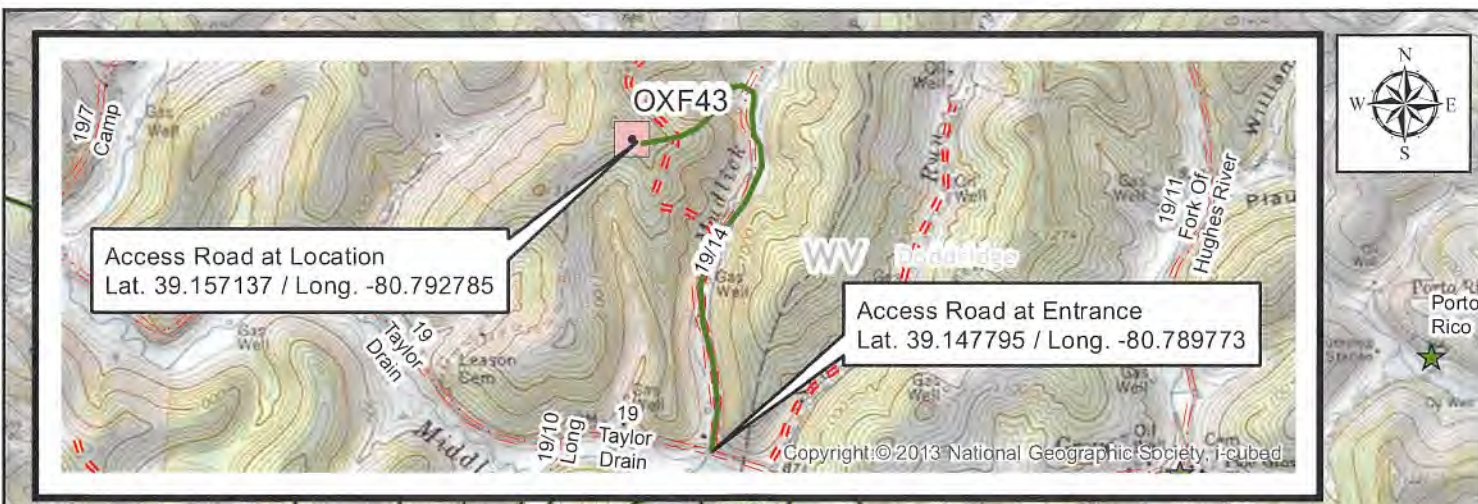

**Legend**

Horizontal PUD Locations	Access Routes	Railroads	College	Law Enforcement
Safety Buffer	Highways	Counties	Fire Department	Church
Tax Parcels	Interstates	Hospital	Hospital	School
LANDMARKS	Major Roads	Streets		
Access Route				

**EQT**

EQT Production  
White Oaks Office  
120 Professional Place  
Bridgeport, WV 26330

**Site Safety Plan**

**OXF43**  
**One Mile Safety Buffer**  
**Doddridge County, WV**

Created By: JG/MSK  
Printed By: JG/MSK on 3/17/2015  
Map Date: 03/17/2015  
Client: Land O'S - White Oaks Office

**DISCLAIMER**  
ALL INFORMATION DEPICTED ON THIS MAP PROVIDED BY EQT (SAID TERM SHALL MEAN EQT PRODUCTION OR EQT MIDSTREAM, DEPENDING ON WHICH EQT ENTITY PROVIDED THE MAP) IS FOR INFORMATION PURPOSES ONLY AND SHALL BE TREATED AS CONFIDENTIAL INFORMATION AND SHALL ONLY BE USED FOR THE SOLE PURPOSE FOR WHICH IT WAS PROVIDED. ANY OTHER USE OF THIS MAP OR THE INFORMATION INCLUDED THEREON IS STRICTLY PROHIBITED. THE EXACT LOCATION OF THE FACILITIES INCLUDING BUT NOT LIMITED TO WELLS, PIPELINES, STRUCTURES, FACILITIES, LEASE BOUNDARIES OR ANY OTHER INFORMATION SHOWN ON THIS MAP SHALL NOT BE RELIED UPON FOR THE SPECIFIC LOCATION OF THE FACILITIES AND THE PARTIES AGREE THAT THE INFORMATION SHOWN ON THE MAP MAY NOT HAVE BEEN PLACED ON THE MAP USING SURVEY LINES OR GPS COORDINATES. EQT MAKES NO EXPRESS OR IMPLIED REPRESENTATION OR WARRANTY AS TO THE ACCURACY OF THE MAP OR THE INFORMATION SHOWN THEREON. THE SPECIFIC LOCATION OF ANY OF THE INFORMATION, INCLUDING ANY WELL, PIPELINE, STRUCTURE, FACILITY OR LEASE BOUNDARY, SHOULD BE DETERMINED BY A FIELD SURVEY PERFORMED BY A LICENSED SURVEYOR UPON CONSULTATION WITH EQT. THIS MAP MAY NOT BE COPIED OR OTHERWISE MADE AVAILABLE TO ANY OTHER PARTY IN PAPER OR ELECTRONIC FORMAT WITHOUT WRITTEN CONSENT FROM EQT. RECIPENT EXPRESSLY AGREES THAT ITS USE AND/OR RELIANCE ON THIS MAP SHALL BE DEEMED ITS AGREEMENT TO THE TERMS SET FORTH ABOVE.



**WV DODDRIDGE COUNTY OXF43 SITE SAFETY PARCEL LIST**

<b>MAP #</b>	<b>TM/PARCEL</b>	<b>NAME - OXF43 Site Safety Parcels</b>	<b>ADDRESS</b>	<b>PHONE</b>
9	2-4-3.1	ARMSTRONG TELEPHONE COMPANY	600 EAST NORTH ST HARRISVILLE WV 26362	304-643-2921

RECEIVED  
Office of Oil and Gas

 DEC 20 2019

WV Department of  
Environmental Protection

### **Section III: Well Work**

This Attached Plan will be reviewed with all employees on the work site prior to beginning their work. Any required changes will be inserted into this Plan and made a part of the Plan after being approved by WVOOG.

#### **Documentation**

A documented EQT Tailgate Safety Meeting (TSM) Form must be completed for each shift which describes the activities occurring, possible hazards and emergency contact information. Originals must be maintained and kept with the EQT OSR and filed with the well documents to serve as verification of the meeting and communication of the shift activities.

#### **Plan Assimilation and Dissemination**

The Supervisor of Environmental and Safety - Drilling, or their designee, shall be responsible for providing a copy of this plan to the local emergency planning committee (LEPC) or county emergency services (CES) office within at least 7 days from land disturbance or well work. The LEPC or CES representative will sign a receipt (See Appendices) documenting this.

A copy of this Plan will be available in the following locations:

- In the on-site mailbox
- In the On-Site Drilling or Completions Specialist office.
- West Virginia DEP Office of Oil and Gas
- LEPC or CES
- Office of the assigned Environmental and Safety Coordinators
- Electronically in EQT *Well File Library* (as part of the permit document).

#### **Personal Protective Equipment (PPE)**

At a minimum, all personnel on-site shall wear the following PPE:

- Flame Resistance Clothing (FRC)
- Hardhat
- Safety glasses with side shields
- Hard toe boots
- Gloves, Leather, Mechanic or Tight –fitting Knit  
(Cut Resistance ANSI Level 3 or greater for EQT employees)

Additional PPE may be required based on unique job hazards such as:

- High visibility vest
- Hearing Protection
- Welding/Cutting/Burning
- Electrical
- Fueling Diesel equipment
- Handling hazardous chemicals/substances

**Note:** Additional PPE may be assigned dependent on the site conditions and shall be the discretion of the on-site specialist and the Environmental and Safety Department. All additional PPE requirements will be communicated to all personnel.

#### **Well Pad Construction Sequence**

Basic Construction Sequence

1. Mobilization
2. Erosion & Sediment Control Install

RECEIVED  
Office of Oil and Gas

 DEC 20 2019

WV Department of  
Environmental Protection

3. Clear & Grub
4. Top soiling
5. Bulk Earthwork (Keyways to finish grade)
6. Stoning & Stabilization
7. Sound wall install (If applicable)
8. Cellar & Conductor install
9. Containment & AST install
  - 9.1. Potential Construction Hazards (29CFR 1926 OSHA Construction Industry Regulations & Standards, July 2017)
  - 9.2 Fire Protection
    - 9.2.1. Fire prevention – burning on-site
  - 9.3. Material Handling, Storage, Use and Disposal
    - 9.3.1. Disposal of waste material – coal, spill clean-up (hydraulic fluid, fuel)
  - 9.4. Tools- Hand and Power (i.e. chainsaw for clearing)
  - 9.5. Welding and Cutting
  - 9.6. Motor Vehicles & Mechanized Equipment
    - 9.6.1. Material handling equipment – limited visibility
    - 9.6.2. Site clearing equipment – limited visibility
    - 9.6.3. Traffic control – off-loading equipment; cutting in entrance to new site
    - 9.6.4. Pile driving equipment
    - 9.6.5. Equipment rollovers
  - 9.7. Excavations
    - 9.7.1. Sloping and benching
    - 9.7.2. Shoring for trenches
    - 9.7.3. Fall protection
  - 9.8. Blasting and Use of explosives
  - 9.9. Electrical
    - 9.9.1. Temporary power run to man camps
    - 9.9.2. Proper grounding
  - 9.10. Confined Spaces
  - 9.11. Cranes and Derricks
  - 9.12. Other General Hazards (i.e. weather conditions, extreme terrain, slips, trips, etc.)

## **MARCELLUS/ UPPER DEVONIAN REGION:**

### **Detail of Well Work, Drilling Operations**

1. Review pertinent well data.
2. MIRU drilling rig.
3. Install riser and air bowl.
4. Drill surface or mine string hole to required depth on air / foam / water based mud.
  - a. Surface casing must be set at least 50' and no more than 150' below the deepest freshwater unless necessary to cover workable coal seams.
  - b. Mine string hole will not be drilled more than 100' below base of the mine. Casing will be set below the mine and a cement basket will be placed above the mine to allow cement to be placed from the basket to surface.
5. Run casing to program depth. Centralize per requirements.
6. Cement to surface per regulation.
7. WOC 8 hrs.
8. Pressure test casing to 20% over Maximum Anticipated Surface Pressure (MASP).

RECEIVED  
Office of Oil and Gas

 DEC 20 2019

WV Department of  
Environmental Protection

9. If separate mine string was required, prepare riser for the drilling of fresh water protective hole section as follows:
  - a. TIH with drilling assembly.
  - b. Drill out mine string and to section TD.
  - c. Run water protective string (surface casing) to prescribed depth per regulation.
  - d. Cement casing to surface per regulation.
  - e. Pressure test casing to 20% over MASP.
  - f. WOC 8 hrs.
10. Install and test wellhead per manufacturer's specification.
11. Install BOP stack.
12. Test BOP's
  - a. Annular Preventer to 70% of rated capacity
  - b. Ram Preventers to 80% of rated capacity
13. MU drilling assembly
14. Drill out surface casing and to planned section TD.
15. Run intermediate casing to programmed depth.
16. Cement intermediate casing to surface per regulation.
17. Pressure Test casing 20% over MASP.
18. WOC 8 hrs.
19. MU drilling assembly
20. Drill out casing. Perform formation integrity test to adequate pressure gradient.
21. Drilling a pilot hole:
  - a. If drilling a pilot hole to tag the Onondaga:
    - i. Drill the pilot hole to tag the Onondaga but no more than 100'.
    - ii. Trip out of hole and run open hole logs per geology.
    - iii. Trip in hole with drill pipe and plug back with solid cement plug to approximately 200' above KOP.
    - iv. Proceed to step 22.
  - b. If not drilling a pilot hole to tag the Onondaga:
    - i. Drill pilot hole to KOP.
    - ii. Trip for directional drilling assembly.
    - iii. Proceed to step 22.
22. MU directional assembly, TIH and drill curve and lateral section of production hole with drilling assembly changes as necessary to achieve the planned wellbore trajectory.
23. Run production casing to programmed depth.
24. Cement production casing per regulation. Planned TOC will be 500' above top producing zone.
25. WOC 8 hrs.
26. Nipple down BOP's and install tubing head. Test tubing head voids per manufacturers recommendation.
27. Install dry hole flange. RDMO drilling rigs.

**First Stage Completion Work**

1. Install containment as required.
2. Move in and rig up to run bond log from attainable total depth to above cement top and marker joint.

RECEIVED  
Office of Oil and Gas

 DEC 20 2019

WV Department of  
Environmental Protection

## Fracture Stimulation

1. Install or expand containment as required.
2. Install two 10K frac valves with a flow cross between them, and a goathead with frac iron. Rig up frac iron and test surface equipment.
3. Open well and test production casing; open the toe popper.
4. Rig up wire line and pump down plug and guns to perforate Stage one. Pump down operations are run under lubricator and pressure control.
5. Frac stage one.
6. Rig up wire line and pump down plug and guns to perforate subsequent stages. Pump down operations are run under lubricator and pressure control.
7. Set plug, perforate and frac subsequent stages.
8. Rig down frac equipment and secure location. Lubricate Back Pressure Valve into B section. Remove one 10K frac valve and flow cross. Install dry hole tree as second barrier.

## Frac Isolation Plug Drill Out & Completions Flow Back Procedure

1. Install annular bop, pipe and blind rams. Rig up Snubbing unit and service rig, or coiled tubing unit. Install flow cross and flow back equipment and pressure test. Remove back pressure valve.
2. Run in hole with tubing and bottomhole assembly and drill all plugs. Returns are taken to the gas separator, gas buster and/or tanks/pits. Gas is sent down sales line or flared. Pressures are maintained at levels below the operating pressure of snubbing unit components.
3. Rig down snubbing unit and rig or coiled tubing unit.
4. Flow back well with gas to sales or flare until well is stabilized.
5. Install Back pressure valve and remove frac valves. Install production tree and lubricate out Back pressure valve. Turn over to production.

## Production Operations

1. Install containment, production equipment, metering equipment, and tankage per program.
2. Test safety systems.
3. Turn well to sales.

## Plugging Operations

1. Notify inspector 24 hrs. prior to commencing operations
2. Check pressure on all casings.
3. Bleed off pressure to tank with secured lines.
4. Nipple up BOP and JU Head Assembly.
5. Hook pump up, load 5 1/2" casing with bentonite gel from TD to 50' below the lowest strata bearing oil, gas, or water.
6. RIH w/wireline and set a CIBP 50' below the lowest strata bearing oil, gas, or water if achievable. Consult with WVDNR if cannot get to desired depth for permission to set as deep as possible. Load casing with freshwater and pressure test casing and CIBP to 1500 psi for 20 minutes.
7. If pressure holds, continue to step #8. If pressure does not hold contact EQT's site supervisor and ODNR oil and gas inspector.

RECEIVED  
Office of Oil and Gas

 DEC 20 2019

25

WV Department of  
Environmental Protection



8. TIH and tag CIBP and run a CBL on 5.5" casing to surface to determine freepoint.
9. TIH with tubing to CIBP and set a 500' C1A cement plug. Check fluid levels prior to all cement jobs.
10. Cement across all gas, oil or water bearing zones with a nonporous material in between cement plugs up to the freepoint of the 5.5".
11. Free point 5 1/2" casing, cut casing @ free point. TOOH 5 1/2" casing.
12. TIH with tubing and set a 100' C1A cement plug 50' in/out of casing cut. TOOH tubing.
13. Run bond log on 9 5/8" casing from 5 1/2" casing cut plug to surface.\* *Note, other perforations and cement plugs or casing cuts may be deemed necessary after review of 9 5/8" casing bond log.*
14. TIH with 9 5/8" CIBP to top of 5 1/2" casing cut plug. Set CIBP.
15. TIH tubing to 9 5/8" CIBP set a 500' C1A cement plug.
16. Cement across all gas, oil or water bearing zones with a nonporous material in between cement plugs up to the freepoint of the 5.5".
17. Erect monument with API#, date plugged, & company name.
18. Reclaim location and road to WVDNR specifications.

## **UTICA REGION:**

### **Detail of Well Work, Drilling Operations**

1. Review pertinent well data.
2. MIRU drilling rig.
3. Install riser and air bowl.
4. Drill surface hole to required depth on air / foam / water based mud.
  - a. Surface casing must be set at least 50' below the deepest fresh water.
5. Run casing to programmed depth. Centralize per requirements.
6. Cement to surface per regulation.
7. WOC 8 hrs.
8. Pressure test casing to 20% over Maximum Anticipated Surface Pressure (MASP).
9. TIH with drilling assembly.
10. Drill out surface casing string and drill to Intermediate 1 TD.
11. Run intermediate 1 casing string to prescribed depth per regulation.
12. Cement casing to surface per regulation.
13. Pressure test casing to 20% over MASP.
14. WOC 8 hrs.
15. Install and test wellhead per manufacturer's specification.
16. Install BOP stack.
17. Test BOP's
  - a. Annular Preventer to 70% of rated capacity
  - b. Ram Preventers to 80% of rated capacity
18. MU drilling assembly
19. Drill out intermediate 1 casing and to Intermediate 2 TD.
20. Run intermediate 2 casing to programmed depth.
21. Cement intermediate 2 casing to 500' above shallowest producing zone per regulation.
22. Pressure Test casing 20% over MASP.
23. WOC 8 hrs.
24. MU drilling assembly
25. Drill out casing. Perform formation integrity test to adequate pressure gradient.

RECEIVED  
Office of Oil and Gas

DEC 20 2019

26

26. Drill pilot hole to 200' below Trenton formation.
27. TOOH and run logs per geology.
28. TOOH with logging tools and TIH with drill pipe. Set cement plug back to KOP.
29. TOOH for directional drilling assembly.
30. MU directional assembly, TIH and drill curve and lateral section of production hole with drilling assembly changes as necessary to achieve the planned wellbore trajectory.
31. Run production casing to programmed depth.
32. Cement production casing 1000' above KOP per regulation.
33. WOC 8 hrs.
34. Nipple down BOP's and install tubing head. Test tubing head voids per manufacturers recommendation.
35. Install dry hole flange. RDMO drilling rigs.

### **First Stage Completion Work**

1. Install containment as required.
2. Install 15K frac valve
3. Move in and rig up WL to run bond log from attainable total depth to above cement top and marker joint.

### **Fracture Stimulation**

1. Install or expand containment as required.
2. Install two 15K frac valves with a flow cross between them, and a goathead with frac iron. Rig up frac iron and test surface equipment.
3. Open well and test production casing; open the toe popper (if toe popper is run).
4. Rig up wire line and pump down plug and guns to perforate Stage one, or use WL tractor or CT. Pump down operations are run under lubricator and pressure control.
5. Frac stage one.
6. Rig up wire line and pump down plug and guns to perforate subsequent stages. Pump down operations are run under lubricator and pressure control.
7. Set plug, perforate and frac subsequent stages.
8. Rig down frac equipment and secure location. Lubricate Back Pressure Valve into B section. Remove one 15K frac valve and flow cross. Install dry hole tree as second barrier.

### **Frac Isolation Plug Drill Out & Completions Flow Back Procedure**

1. Install annular bop, pipe and blind rams. Rig up Snubbing unit and service rig, or coiled tubing unit. Install flow cross and flow back equipment and pressure test. Remove back pressure valve.
2. Run in hole with tubing and bottomhole assembly and drill all plugs. Returns are taken to the gas separator, gas buster and/or tanks/pits. Gas is sent down sales line or flared. Pressures are maintained at levels below the operating pressure of snubbing unit components.
3. Rig down snubbing unit and rig or coiled tubing unit.
4. Flow back well with gas to sales or flare until well is stabilized.
5. Install Back pressure valve and remove frac valves. Install production tree and lubricate out Back pressure valve. Turn over to production.

RECEIVED  
Office of Oil and Gas

DEC 20 2019

WV Department of  
Environmental Protection

## Production Operations

1. Install containment, production equipment, metering equipment, and tankage per program.
2. Test safety systems.
3. Turn well to sales.

## Plugging Operations

1. Notify inspector 24 hrs. prior to commencing operations
2. Check pressure on all casings.
3. Bleed off pressure to tank with secured lines.
4. Nipple up BOP and JU Head Assembly.
5. Hook pump up, load 5 ½" casing with bentonite gel from TD to 50' below the lowest strata bearing oil, gas, or water.
6. RIH w/wireline and set a CIBP 50' below the lowest strata bearing oil, gas, or water if achievable. Consult with WVDNR if cannot get to desired depth for permission to set as deep as possible. Load casing with freshwater and pressure test casing and CIBP to 1500 psi for 20 minutes.
7. If pressure holds, continue to step #8. If pressure does not hold contact EQT's site supervisor and ODNR oil and gas inspector.
8. TIH and tag CIBP and run a CBL on 5.5" casing to surface to determine freepoint.
9. TIH with tubing to CIBP and set a 500' C1A cement plug. Check fluid levels prior to all cement jobs.
10. Cement across all gas, oil or water bearing zones with a nonporous material in between cement plugs up to the freepoint of the 5.5".
11. Free point 5 ½" casing, cut casing @ free point. TOOH 5 ½" casing.
12. TIH with tubing and set a 100' C1A cement plug 50' in/out of casing cut. TOOH tubing.
13. Run bond log on 9 5/8" casing from 5 ½" casing cut plug to surface. \* *Note, other perforations and cement plugs or casing cuts may be deemed necessary after review of 9 5/8" casing bond log.*
14. TIH with 9 5/8" CIBP to top of 5 ½" casing cut plug. Set CIBP.
15. TIH tubing to 9 5/8" CIBP set a 500' C1A cement plug.
16. Cement across all gas, oil or water bearing zones with a nonporous material in between cement plugs up to the freepoint of the 5.5".
17. Erect monument with API#, date plugged, & company name.  
Reclaim location and road to WVDNR specifications

RECEIVED  
Office of Oil and Gas

DEC 20 2019

WV Department of  
Environmental Protection

## **Section IV: Chemical Inventory & SDS**

### **Safety Data Sheets (SDS):**

SDS for all materials and chemicals on-site will be maintained and readily available at the well site. Copies of these SDS will be kept in the EQT On-site Offices, or be available on-line and be the responsibility of the EQT On-site Specialist. An electronic copy of the Anticipated SDS will be submitted to the Department as well.

### **Mud Information**

There will be one induction style mud hopper on location for mixing the fluid.

<b>Mud Usage Marcellus/Upper Devonian Region</b>		<b>Mud Usage Utica Region</b>	
Mix Mud Amount	2000 – 3500 bbls	Mix Mud Amount	2000 – 3500 bbls
Mud Weights	8.5 – 14.8 ppg	Mud Weights	8.5 – 18.5 ppg
Volume Mixing Water	275 – 2750 bbls	Volume Mixing Water	275 – 2750 bbls

RECEIVED  
Office of Oil and Gas

 DEC 20 2019

WV Department of  
Environmental Protection

Below table contains the inventory of on-site materials for mixing mud.

Product Name	General Description	Possible Inventory	Package Size
ALDACIDE G	Bacteria prevention	0 – 32	5 gallon can
BARABLOK	Fluid loss additive	0 – 100	50 lbs. sack
BARACARB 50, 150, 600	Lost circulation material	0 – 150	50 lbs. sack
BARACOR 700	Corrosion inhibitor	0 – 4	55 gallon drum
BARA-DEFOAM W300	Mud defoamer	0 – 32	5 gallon can
BARAZAN-D PLUS	Viscosifier	0 – 80	25 lbs. sack
BAROFIBRE	Lost circulation material	0 – 100	25 lbs. sack
BAROID 41	Weighting agent	0 – 80	Bulk tons
BARO-SEAL COARSE	Lost circulation material	0 -100	50 lbs. sack
Bicarbonate of soda	Calcium control	0 – 49	50 lbs. sack
Calcium chloride powder	Salinity control	0 – 160	50 lbs. sack
Caustic soda	pH/alkalinity control	0 – 25	50 lbs. sack
Citric acid	pH/alkalinity control	0 – 25	50 lbs. sack
DEXTRID LT	Fluid loss additive	0 – 100	50 lbs. sack
DRILTREAT	Wetting agent/emulsifier	0 – 16	5 gallon can
EZ-MUD	Shale inhibitor	0 – 10	5 gallon can
GELTONE V	Viscosifier	0 – 50	50 lbs. sack
LE SUPERMUL	Emulsifier	0 – 16	55 gallon drum
Lime	pH/alkalinity control	0 – 50	50 lbs. sack
N-SEAL	Lost circulation material	0 – 100	50 lbs. sack
NXS-LUBE	Lubricant	0 – 16	5 gallon can
OMC 42	Mud conditioner	0 – 4	55 gallon drum
PAC-L	Fluid loss additive	0 – 80	50 lbs. sack
QUIK-THIN PLUS	Mud thinner	0 – 100	50 lbs. sack
RHEMOD I	Mud conditioner	0 – 8	55 gallon drum
RM 63	Mud conditioner	0 – 8	55 gallon drum
Soda Ash	Calcium control	0 – 25	50 lbs. sack
Sodium chloride	Salinity control	0 – 30	2,000 lbs. sack
STEELSEAL 400	Lost circulation material	0 – 200	50 lbs. sack
SUSPEMSTONE	Suspension agent	0 – 100	50 lbs. sack
SynOil	Base oil	0 – 150	bbls (42 gal)
WALL-NUT MEDIUM	Lost circulation material	0 – 150	50 lbs. sack
ZEOGEL	Viscosifier	0 - 100	50 lbs. sack

RECEIVED  
Office of Oil and Gas

DEC 20 2019

WV Department of  
Environmental Protection

## Section V: BOP and Well Control

### BOP equipment and assembly installation schedule

<b>BOP Equipment – Marcellus/Upper Devonian Region</b>						
Size (in)	Operation	Hole Section	Type	Pressure Class	Test Pressure (psi)	Test Frequency
13-5/8"	Drilling	Intermediate	Annular	3M	2,100	Initial
13-5/8"	Drilling	Pilot	Annular	3M	2,100	Initial, Weekly, Trip
13-5/8"	Drilling	Production	Annular	5M	3,500	Initial, Weekly, Trip
13-5/8"	Drilling	Production	Blind	5M	4,000	Initial, Weekly, Trip
13-5/8"	Drilling	Production	Pipe	5M	5,000	Initial, Weekly, Trip
7-1/16"	Completions	Production	Cameron U's	5M	5,000	Initial
13-5/8"	Drilling	Pilot (Onondaga Tag)	Annular	5M	4,000	Initial, Weekly, Trip

<b>Wellhead Detail – Marcellus/Upper Devonian</b>		
Size (in)	Type	M A W P (psi)
13-3/8" SOW x 13 5/8" 5M	Multi-bowl Well Head	5,000
13-5/8" 5M x 7-1/16" 10M	Tubing Head	10,000
2-1/16" 5M	Christmas Tree	5,000

### **Utica Region**

Test BOPs as follows:

- Annular to 250 psi low/2,100 psi high for 30 mins each
- All ram, choke/kill valves, TIW, IBOP and all choke manifold valves to 250 psi low/4,000 psi high for 30 mins each
- Annular to 250 psi low/3,500 psi high for 30 mins each
- All ram, choke/kill valves, TIW, IBOP and all choke manifold valves to 250 psi low/8,000 psi high for 30 mins each

<b>BOP Equipment – Utica Region</b>						
Size (in)	Operation	Hole Section	Type	Pressure Class	Test Pressure (psi)	Test Frequency
13 5/8"	Drilling	Intermediate	Annular	3M	2,100	Initial, Weekly, Trip
13 5/8"	Drilling	Intermediate	Pipe	5M	4,000	Initial, Weekly, Trip
13 5/8"	Drilling	Intermediate	Blind	5M	4,000	Initial, Weekly, Trip
13 5/8"	Drilling	Pilot/Production	Annular	5M	3,500	Initial, Weekly, Trip
13 5/8"	Drilling	Pilot/Production	Pipe	10M	8,000	Initial, Weekly, Trip
13 5/8"	Drilling	Pilot/Production	Blind	10M	8,000	Initial, Weekly, Trip

RECEIVED  
Office of Oil and Gas

DEC 20 2019

Wellhead Detail – Utica		
Size (in)	Type	M A W P (psi)
13-3/8" SOW x 13-5/8" 10M	Multi-bowl Well Head	10,000
13 5/8" 10M x 7 1/16" 15M	Tubing Head	15,000
2 9/16" 10M	Christmas Tree	15,000

**Well Control Trained Personnel:**

Drilling

- EQT On-Site Specialist – 2 on rotating hitches.
- Contract Group's – Tool Pusher & Drillers

Completions & Production

- EQT On-Site Specialist or Consultant

**Notification Procedure**

**Significant Event Notifications**

- A detailed record of significant drilling events will be recorded in the EQT Production Well Log Book.
- In addition to the record above, the local inspector of the WV DEP Office of Oil and Gas and Supervisor of EH&S will be notified by the EQT On-Site Specialist for the following events:
  - Lost Circulation
  - Encounter of Hydrogen Sulfide Gas
    - Immediate notification is required of any reading of Hydrogen Sulfide Gas greater than 10ppm
  - Fluid Entry
  - Abnormal Pressures
  - Blow-outs
  - Significant kicks
- Contact information can be found in Section II

**Emergency Notifications**

- In the event emergency response personnel and residents surrounding the work site are affected by specific events during the operation they must be notified as soon as possible by the On-site Specialist or their designee.

**Flaring Notifications**

- The local fire department(s) and/or county dispatch centers must be notified immediately prior to the ignition of a flare.

RECEIVED  
Office of Oil and Gas

 DEC 20 2019

WV Department of  
Environmental Protection

**Marcellus/Upper Devonian Region Well Head Assembly Design, version 1.**

Written Description:

Multi-bowl wellhead assembly with a 13 3/8" 5M x 13 3/8" SOW wellhead. A 13 5/8" 5M x 11" 5M DSA is used between the wellhead and tubing head. The tubing head is 11" 5M x 7 1/16" 10M. The tree is 2 1/16" 5M. Picture of stack up below.

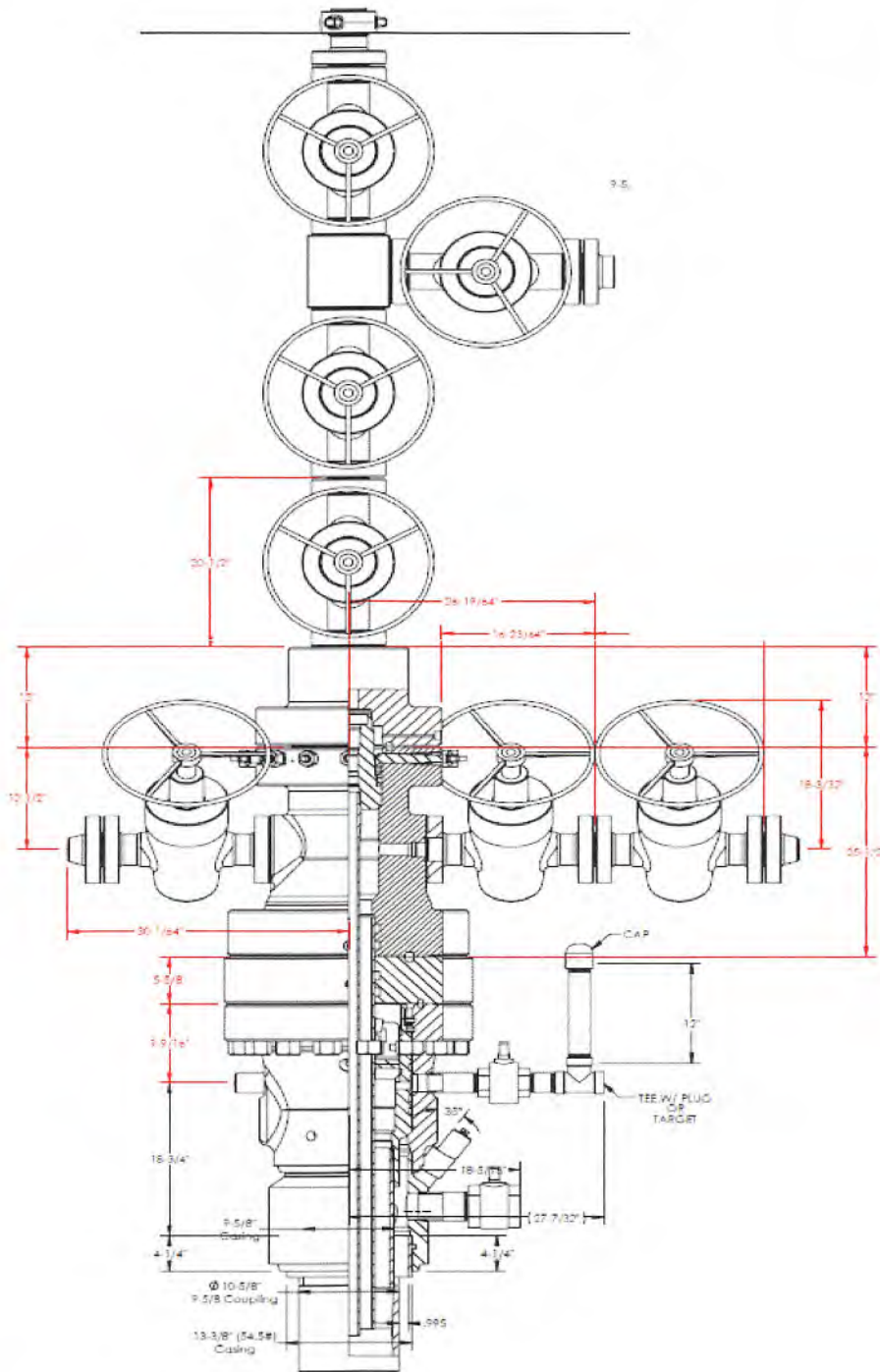

RECEIVED  
Office of Oil and Gas

DEC 20 2019

WV Department of  
Environmental Protection



## Marcellus/Upper Devonian Region Well Head Assembly Design, version 2.

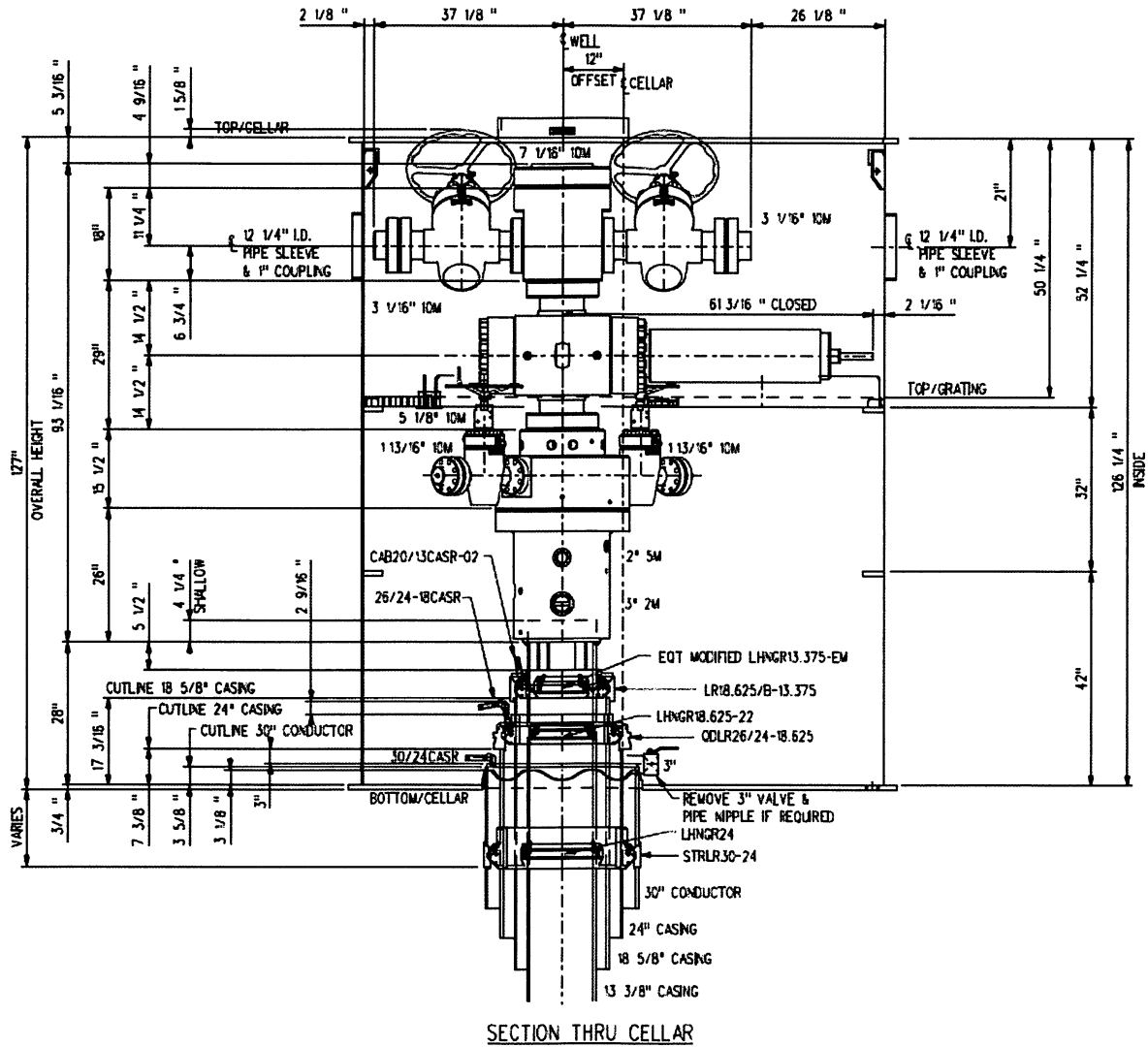

COPYRIGHT © 2017 CELLAR TECH, LLC. DRAWING NO. EQT-110817-1		DRAWING ISSUED DATE: 03/08/17		<h3 style="margin: 0;">CELLAR TECH</h3> CONTAINMENT WELL CELLAR SYSTEMS	
THIS DRAWING CONTAINS PROPRIETARY INFORMATION AND TECHNOLOGY OF CELLAR TECH, LLC. ANY PERSON VIEWING THIS DRAWING AGREES TO KEEP ALL INFORMATION CONTAINED HEREIN CONFIDENTIAL. THIS INFORMATION SHALL NOT BE REPRODUCED OR DISCLOSED TO ANY OTHER INDIVIDUAL OR ORGANIZATION WITHOUT THE WRITTEN CONSENT OF AN OFFICER OF CELLAR TECH, LLC. THIS DRAWING MAY ALSO BE PROTECTED BY CELLAR TECH, LLC PATENTS.		REFERENCE <input type="checkbox"/> PROGRESS <input type="checkbox"/> PRELIMINARY <input type="checkbox"/> APPROVAL <input type="checkbox"/> DESIGN <input type="checkbox"/> MATERIAL <input type="checkbox"/> CONSTRUCTION <input type="checkbox"/> REVISION <input type="checkbox"/> AS BUILT		EQT PRODUCTION MODEL: EQT - 1087207-26-02	
11/08/17 DEF		DATE: 03/08/17    APPR.: JR		CELLAR TECH JOB NUMBER <b>HNGR. MAKE-UP</b>	
A 11/08/17 REC ISSUED FOR REFERENCE		SCALE: 3/4"=1'-0"    CHD.:		CELLAR TECH DRAWING NUMBER <b>EQT-SK-110817-1</b>	
REV.	DATE	BY	DESCRIPTION	BY:	REC

RECEIVED  
Office of Oil and Gas

DEC 20 2019

WV Department of  
Environmental Protection

# Utica Region Well Head Assembly Design

## Written Description:

Multi-bowl wellhead assembly with a 13 5/8" 10M x 13 3/8" SOW wellhead. A 13 5/8" 10M x 7 1/16" 15M DSA is used between the wellhead and tubing head. The tubing head is 7 1/16" 15M x 7 1/16" 15M. The tree is 2 9/16" 15M. Picture of stack up below.

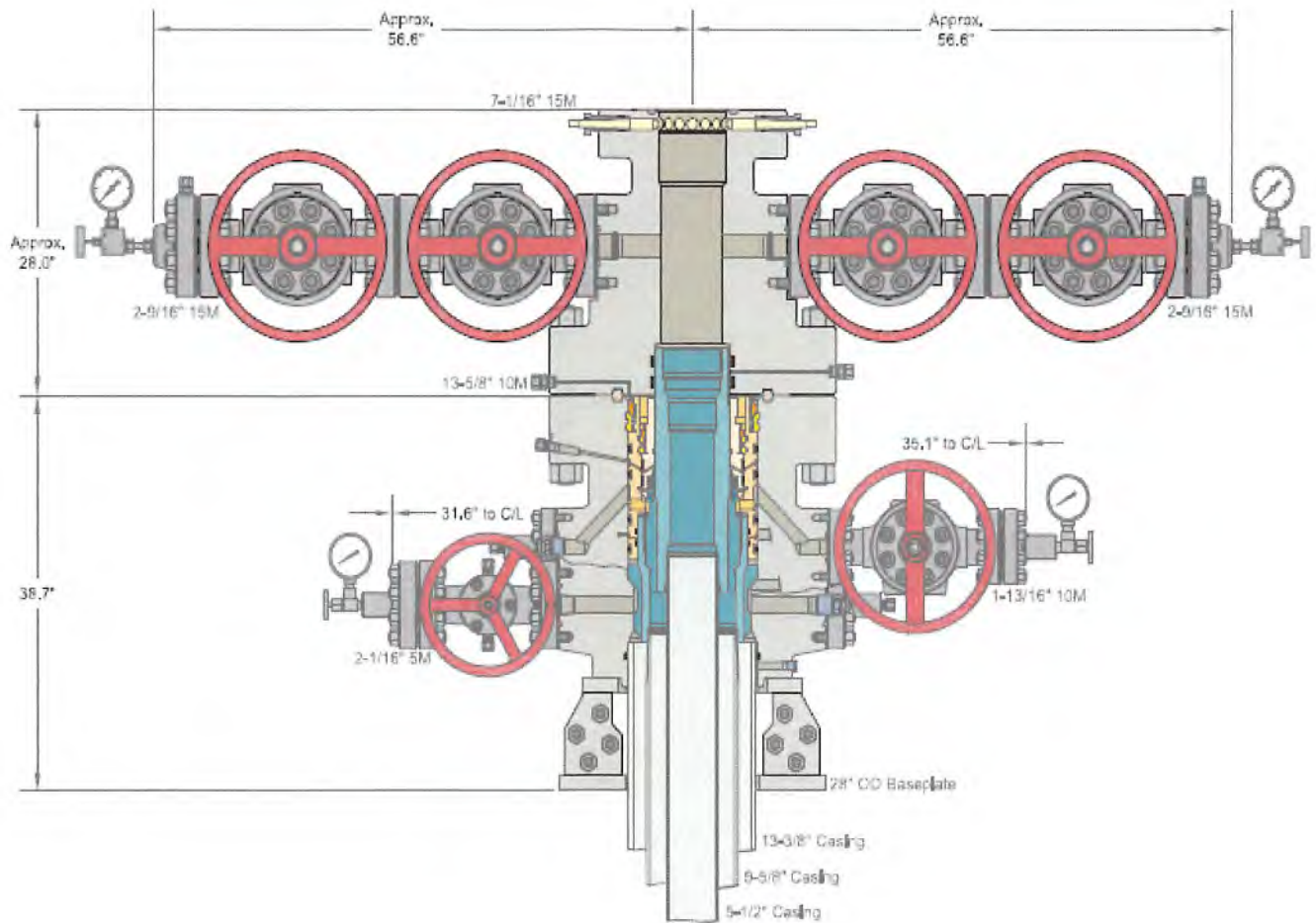

INFORMATION CONTAINED HEREIN IS THE PROPERTY OF CACTUS WELLHEAD, LLC. REPRODUCTION, DISCLOSURE, OR USE THEREOF IS PERMISSIBLE ONLY AS PROVIDED BY CONTRACT OR AS EXPRESSLY AUTHORIZED BY CACTUS WELLHEAD, LLC.

<b>CACTUS WELLHEAD LLC</b>		<b>EQT PRODUCTION NORTHEAST</b>	
13-3/8" X 9-5/8" X 5-1/2" MBU-2LR Wellhead Assembly With 13-5/8" 10M x 7-1/16" 15M CTH-DBLHPS Tubing Head & 2-9/16" 15M Tubing Head Valves		DRAWN	DLE 04NOV15
		APPRV	
		DRAWING NO.	DNE0000013

RECEIVED  
Office of Oil and Gas

DEC 20 2019

## Well Kill Killing Operations

In a well control situation, all influxes are to be handled using the Wait-and-Weight Method or the Driller's Method. With the Wait-and-Weight Method, the influx is circulated out while kill weight mud is simultaneously circulated down the drill pipe and up the annulus. The heavy mud is circulated to the bit at a slow kill rate, and the drill pipe pressure is maintained according to a prepared table that gives drill pipe pressure for the corresponding strokes of kill mud pumped.

The Driller's Method is accomplished in two circulations using constant drill pipe pressure and maintaining constant pump speed. The drill pipe pressure is kept constant by adjusting the choke. Once the annulus is clear of the influx, the mud weight is adjusted to kill-weight. The kill-weight mud is then circulated to the bit using constant pump speed and drill pipe pressure step-down plan. When kill-weight mud has reached the bit, the FCP is maintained until the heavy mud has reached the surface.

RECEIVED  
Office of Oil and Gas

DEC 20 2019

WV Department of  
Environmental Protection

## **Section VI: Hydrogen Sulfide**

### **Purpose**

The purpose of this plan is to insure the safety of the all on-site personnel as well as those residents in close proximity. Hazards associated with the possibility of H<sub>2</sub>S encounters and the warning signs of H<sub>2</sub>S exposure will be covered.

### **Scope**

The policy is to consider every encounter with H<sub>2</sub>S as potentially lethal until proven otherwise. Upon encountering H<sub>2</sub>S, EQT employees or contractors(s) will determine the concentration of H<sub>2</sub>S.

### **General Information**

Immediately upon suspicion or odor of H<sub>2</sub>S on location, the concentration shall be determined using properly functioning single or multi-gas detection devices which have a sensor calibrated to detect the presence of H<sub>2</sub>S gas.

- All readings should be documented along with the time they were obtained
- All areas having a reading of greater than 10 ppm H<sub>2</sub>S shall be evacuated until the area has been cleared of H<sub>2</sub>S, or properly trained personnel equipped with appropriate PPE arrive on location.
- H<sub>2</sub>S deadens the sense of smell; the presence or absence of H<sub>2</sub>S odor is not an acceptable means for determining the presence of gas.
- Never walk upwind or uphill towards any suspected source of H<sub>2</sub>S; approach using a cross wind approach.

Identify wind direction and evacuate personnel upwind and uphill of the leak; H<sub>2</sub>S is heavier than air and will settle in low-lying areas.

If necessary, the well will be shut in and the work will be stopped until adequate safety personnel and equipment have arrived on site.

No work will take place until the appropriate personnel and equipment are in place.

The primary considerations at this time will be:

- H<sub>2</sub>S concentration
- Gas Volume
- Weather Conditions
- Dwellings in the area.

### **Personal Protective Equipment**

1. The EQT H<sub>2</sub>S contractor will have an emergency trailer with SCBA's, additional gas detection equipment and other instrumentation and PPE required for appropriate response.
2. All personnel on location; all personnel monitoring adjacent to the location; or all personnel associated with the operation, will be equipped with personal H<sub>2</sub>S monitors.
3. There will be a H<sub>2</sub>S monitor located at the flow line exit, during the drilling of this well, as well as on the Rig Floor.
4. This PPE shall be in addition to the PPE requirements listed in EQT's General Safety Policies and Procedures.

RECEIVED  
Office of Oil and Gas

DEC 20 2019

WV Department of  
Environmental Protection

## Training

Only personnel whom have been properly trained; or are qualified in the hazards of H<sub>2</sub>S, will be allowed on location during operations that have encountered, or projected to encounter H<sub>2</sub>S.

- There will be a safety briefing prior to start of each shift or tower and hazards and currently readings of H<sub>2</sub>S will be documented on a TSM or JSA.

## Personnel Accountability and Briefing (Assembly) Areas

The sign in sheet of the EQT Tailgate Safety Meeting (TSM) Form shall be used for Accountability of on-site personnel as well as visual confirmation with the current supervisor of the site. Personnel should not leave the site without first informing their immediate supervisor, Emergency Coordinator, and/or On-Site Representative (OSR).

- The sign in roster is located at: **EQT Company Trailer**
- Primary Assembly Area: **EQT Company Trailer**
- Secondary Assembly Area: **Access road intersection with pad entry**
- Tertiary Assembly Area: **Start of the access road or a safe location chosen based on conditions.**

Specific considerations for H<sub>2</sub>S should include:

- Windsocks or streamers for indication of wind direction.
- Being upwind of harmful levels of H<sub>2</sub>S
- Avoiding low lying areas

Signage will be utilized along the location road, or any other entrances to the location, if H<sub>2</sub>S is encountered.

## H<sub>2</sub>S Response Team Contractors

- The designated EQT Hydrogen Sulfide Emergency Response Company will be determine based on availability, location of the incident and master service agreements maintained by EQT.

## Emergency numbers

- See Section I for emergency contact information.

## Site Access

- See Section II: Site Access for information.

## Notifications

The EQT H<sub>2</sub>S Contractor will be notified at the following intervals if operations are occurring on a suspected H<sub>2</sub>S location:

- Pre-Spud Meeting
- Spud Date
- Bottom of 9 5/8"
- 1000' Above Onondaga

RECEIVED  
Office of Oil and Gas

DEC 30 2019

WV Department of  
Environmental Protection

## **Protection Zone Plans**

### **Emergency Protection Zone Plan**

In the event of an emergency on the well site, the Emergency Coordinator, or his designee, shall determine protective zones to limit the risk of exposure to workers, local responders, and residents surrounding the work area.

- The attached Safety Zone Map and Parcel Owners listed in Section II of this plan can be utilized.

Life safety, impacts to the environment, and property conservation are priorities.

The Emergency Coordinator shall determine these zones based on the following information on the scene:

- Magnitude of the incident
- Wind Direction
- MSDS of applicable materials
- Current and forecasted weather conditions
- Topography and land conditions
- Other influences specific to the incident

Once established, these zones will be maintained until a determination is made by the Emergency Coordinator to alter or discontinue them.

### **Flowback Condensate Protection Zone Plan**

A pre-job meeting or contact will be performed with all parties prior to startup.

Equipment and operational guidelines are:

- Permit entry only 30' radius around gas buster tanks.
- Signs posted around well site.
- Gas detectors and condensate sticks will be on location and used.
- Approved vendors only for condensate transfer to pre-approved sites.
- Emergency response plan reviewed for either WV or PA operations.
- EQT On-Site Completion Specialist (OCS) will be notified immediately of any liquids on the ground.
- Only approved companies and vacuum trucks to be used to pick up fluids.
- LEL meter usage verified and to be checked.
- All ignition sources around well site will be reviewed.

RECEIVED  
Office of Oil and Gas

DEC 20 2019

WV Department of  
Environmental Protection

## **Section VII: Flaring**

### **Flaring Operations**

#### **Drilling**

##### **Flare Line Installation**

The BOP equipment will all be located on the surface. The choke line coming off the stack will lead into a 5,000 psi choke manifold with 2 adjustable chokes. The 7" blooie line will divert any gas 50-75' away from rig substructure. Blooie line will be properly anchored with stakes or buried and will be set up so that gas can be vented. There will be a clearing of 25' for the gas to be vented. Duration of flare is expected to be ~ 7 days, depending on actual test results.

##### **Ignition Methods**

1. Primary – Vent
2. Backup – Marine flare pistol

##### **Notification**

Notification of a Flare will be given to the local Fire Department and/or 911 center, if possible. Refer to Section 3.0 for contact information.

### **Completions**

##### **Flare Line Installation – Marcellus/ Upper Devonian Region**

The Flare Stacks will be positioned in a safe area at least 25' away from pit liners, trees and any other hazardous sites. The Flowback configuration consist of in order: 7 and 1/16" 10m frac valve; Flow Cross with 4 and 1/16" wing valve ; junk catcher; choke manifold; 1440 psi or 2000 psi horizontal test separator and 2" 206 pipe to Flare Stack. Flowline will be properly anchored and tethered. Duration of flare is expected to be ~ 7 days, depending on actual test results.

##### **Ignition Methods**

1. Primary –Pilot Light

##### **Flare Line Installation – Utica Region**

The Flare Stacks will be positioned in a safe area at least 25' away from pit liners, trees and any other hazardous sites. The Flowback configuration consist of in order: 7 and 1/16" 10m frac valve; Flow Cross with 4 and 1/16" wing valve ; junk catcher; choke manifold; 1440 psi or 2000 psi horizontal test separator and 2" 206 pipe to Flare Stack. Flowline will be properly anchored and tethered. Duration of flare is expected to be ~ 7 days, depending on actual test results

##### **Ignition Methods**

1. Primary –Pilot Light

##### **Notification**

Notification of a Flare will be given to the local Fire Department and/or 911 center, if possible. Refer to Section II for contact information.

RECEIVED  
Office of Oil and Gas

DEC 20 2019

WV Department of  
Environmental Protection

RECEIVED  
 Office of Oil and Gas  
 DEC 20 2019  
 WV Department of  
 Environmental Protection



LEGEND		REVISED BY:	DATE:
	= Existing Wells	Chris Harmon	10/30/2019
	= Future Wells		
	= Pad & Berm		
	= Access Road		

**EQT** OXF43 Flare Diagram  
 Southwest Twp, Doddridge Co., WV  
 Scale: 1" = 50' 1 of 1



## **Section VIII: Collision Avoidance**

Collision avoidance is managed by utilizing gyro tools, downhole steering tools (MWD/EM), and anti-collision software by engineers. Two drilling scenarios that occur are normal pad drilling and return to pad drilling. EQT categorizes these two scenarios as such because the two scenarios utilize very different mitigation plans.

Normal pad drilling is defined when a top hole rig drills each well on the pad down to kick off point (KOP) and then a bottom hole rig moves onto the pad after the top-hole rig moves off and drills the curve and lateral sections. Normal pad drilling can also be defined when a bottom hole rig moves to a pad and drills each well on the pad from surface to TD (Grassroots Well). Normal pad drilling carries much less risk and thus does not require frequent surveying and collision avoidance maneuvers because no producing wells are present and risk of unexpected pressure or well control events are not present.

Return to pad drilling is a scenario where a top-hole rig or a bottom hole rig returns to a pad to drill additional well(s) that currently have producing (live) wells on the pad. Return to pad drilling requires more frequent surveying and anti-collision avoidance management because producing wells are present. By utilizing good engineering well design, anti-collision software and frequent surveys, wells can safely be drilled while existing or producing wells exist on the pad.

With both normal and return to pad drilling operations, every well planned to be drilled has a surface plot diagram, 2-D plot diagram, and a pad plot diagram prepared. (Plots attached under "Collision Avoidance Diagrams") In each scenario, a continuous north seeking gyro tools, MWD/EM tools, and anti-collision processes are utilized to mitigate the risk of downhole collisions. Anti-collision processes include conformation of gyro accuracy, evaluation of anti-collision software (Compass or equivalent program), and 2-D/3-D model plotting. In both scenarios, it is EQT's standard operating procedure (SOP) for the on-site supervisor of EQT and the directional drilling company supervisor to confirm the orientation of the directional tools and ensure that the tools are orientated consistent with the directional motor's high side. When anti-collision is a risk and directional assemblies are required to navigate utilizing a gyro tool, it is EQT's SOP to use the Gyro company's muleshoe to ensure the accuracy of the gyro seat in the muleshoe. In addition, when using this muleshoe, it is EQT's SOP to have the EQT's on-site supervisor, directional drilling company supervisor, and gyro company supervisor confirm the alignment and orientation of the tool and ensure that the tools are orientated consistent with the directional motor's high side. This ensures the azimuthal direction is correct when steering the well.

### **Normal Pad Drilling**

In this scenario, there are no existing wells on the pad. A top-hole rig will move on to the pad and drill each well to KOP and then a bottom hole rig will move on after the top hole rig finishes and drill the each well to horizontal TD. At times, the bottom hole rig may drill each well from surface to horizontal TD.

During this scenario, if two wells come within 10 feet or a separation factor of 1.5, each survey is monitored closely and anti-collision is run after each survey until the wells are clear of a collision risk. The frequency of surveys can vary from 30-500' depending on the trajectory of the wells, hole walk, and risk of collision. If a  $SF \leq 1.0$  or  $\leq 5'$  separation is encountered or a collision occurs, an email notification will be sent by the EQT on-site drilling supervisor to the appropriate state inspector. In the event the proximity of wells get to a point where a collision cannot be avoided or a collision occurs, EQT will properly secure each well and evaluate the most prudent plan forward while communicating plans with the state inspector.

RECEIVED  
Office of Oil and Gas

 DEC 20 2019

### Vertical Section:

Each hole is drilled to KOP by either the top-hole rig or bottom hole rig. Once KOP is achieved then a gyro survey is run. No nudges are planned.

- Each gyro is analyzed and certified accurate by the gyro company before it is used for any directional planning or modeling. Each tool is roll tested on location and if all surveys are within tolerances the gyro survey is sent to the gyro company's office to be further analyzed and certified accurate.

### Horizontal Section:

After the top-hole section of the well is complete and the well is at KOP, anti-collision is run on each well and the most efficient well path with the lowest risk of collision is selected by engineers. Directional bottom hole assemblies (BHA) are run in the hole and used to drill the well from vertical to horizontal. Gyros or MWD/EM surveys are taken as needed to steer the well until the well is away from the other wells and the risk of collision is eliminated. Surveys utilizing MWD/EM tools are taken from that point on to the total depth of the well is achieved. After each survey is taken, the surveys are analyzed by both EQT engineers and the directional drilling well planning technicians and anti-collision is run to ensure current well path is not in the direction of a producing well(s) and consistent with the permitted well path.

- Anti-Collision is a software program into which gyro surveys or MWD/EM surveys are uploaded. The software runs 2-D and 3-D well paths of all wells within the vicinity of the well being drilled.
- Surveys are taken every 30-100'.
- While directionally drilling the well, anti-collision software is constantly updated and separation factors (SF) are analyzed.
- Each survey is analyzed and certified accurate by the directional company before it is used for any directional planning or modeling.

### **Return to Pad Drilling**

In this scenario a top-hole rig or bottom hole rig will move on a pad that currently has producing (live) wells on the pad. Prior to drilling additional wells on the pad, the gyro from the existing wells on the pad are analyzed by engineers to evaluate how the existing wells walk in the vertical part of the well. Then preliminary directional plans are prepared to mitigate downhole collisions. EQT plans to drill and develop the pad while producing existing offset wells. However, additional well path management (more frequent surveying and anti-collision modeling) is performed by engineers during the drilling process both in the vertical and horizontal sections of each well.

During this scenario, the well is surveyed from surface to TD as it is drilled and if two wells come within 14 feet or a SF of 2.0, each survey is monitored closely and anti-collision is run after each survey until the wells are clear of a potential collision. The frequency of surveys can vary from 30-500' depending on the trajectory of the wells, hole walk, and risk of collision. If a  $SF \leq 1.0$  or  $\leq 5'$  separation is encountered, an email notification will be sent by the EQT on-site drilling supervisor to the appropriate state inspector. In the event the proximity of wells get to a point where a collision cannot be avoided, EQT will properly secure each well and evaluate the most prudent plan forward while communicating plans with the state inspector.

RECEIVED  
Office of Oil and Gas

DEC 20 2019

WV Department of  
Environmental Protection

### Vertical Section:

After the rig moves on the pad and starts drilling, gyro surveys are taken several times from surface to KOP. After each gyro is taken, the surveys are analyzed by both EQT engineers and the directional drilling well planning technicians and anti-collision is run to ensure current well path is not in the direction of a producing well(s). All of these steps are completed prior to the resumption of drilling. Actual frequency of gyros is determined by engineers and the position of the hole as it relates to existing wells on the pad. No nudges are planned.

- Anti-Collision is a software program into which gyro surveys or MWD/EM surveys are uploaded. The software runs 2-D and 3-D well paths of all wells within the vicinity of the well being drilled.
- While vertically drilling the well, anti-collision software is constantly updated and separation factors (SF) are analyzed.
- Each gyro is analyzed and certified accurate by the gyro company before it is used for any directional planning or modeling. Each tool is roll tested on location and if all surveys are within tolerances the gyro survey is sent to the gyro company's office to be further analyzed and certified accurate.

### Horizontal Section:

Directional BHAs are run in the hole and used to drill the well from vertical to horizontal. Gyros or MWD/EM surveys are taken as needed to steer the well until the well is away from the other wells and the risk of collision is eliminated. Surveys utilizing MWD/EM tools are taken continuously until the total depth of the well is achieved. After each survey is taken, the surveys are analyzed by both EQT engineers and the directional drilling well planning technicians and anti-collision is run to ensure current well path is not in the direction of a producing well(s) and consistent with the permitted well path.

- Anti-Collision is a software program into which gyro surveys or MWD/EM surveys are uploaded. The software runs 2-D and 3-D well paths of all wells within the vicinity of the well being drilled.
- Surveys are taken every 100'.
- While directionally drilling the well, anti-collision software is constantly updated and separation factors (SF) are analyzed.
- Each survey is analyzed and certified accurate by the directional company before it is used for any directional planning or modeling.

RECEIVED  
Office of Oil and Gas

DEC 20 2019

WV Department of  
Environmental Protection



Where energy meets innovation.

# EQT PRODUCTION

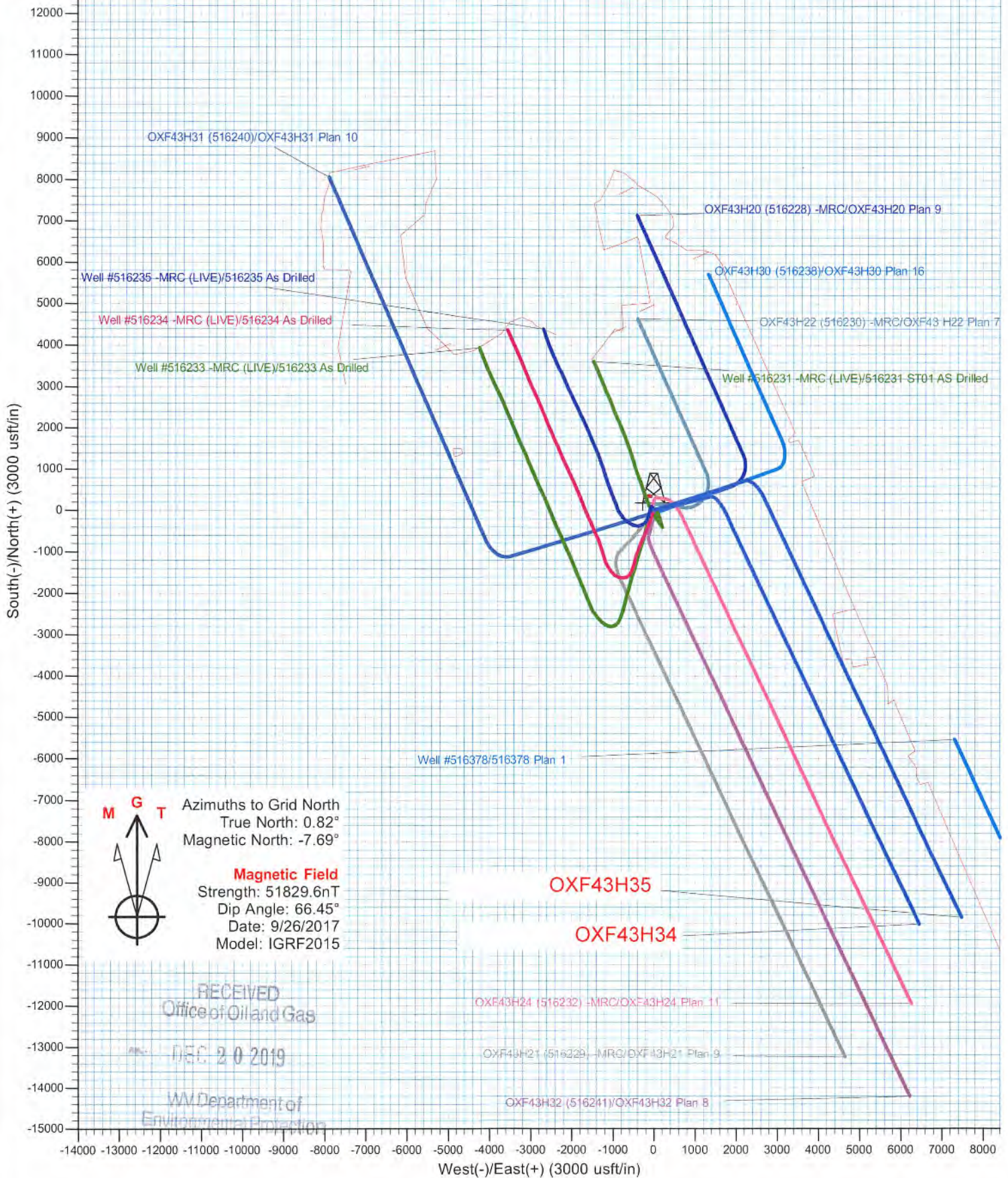

Azimuths to Grid North  
 True North: 0.82°  
 Magnetic North: -7.69°

**Magnetic Field**  
 Strength: 51829.6nT  
 Dip Angle: 66.45°  
 Date: 9/26/2017  
 Model: IGRF2015

RECEIVED  
 Office of Oil and Gas

DEC 20 2019

WV Department of  
 Environmental Protection

## **Section IX: Deep Well Additional Requirements (IF APPLICABLE)**

### **Formations**

See the attached WV Geological Prognosis on the following pages for each well listed on the permit cover page which lists anticipated freshwater, saltwater, oil and gas, hydrogen sulfide, thief zones, high pressure and volume zones and their expected depths

### **Casing and Cementing**

SEE ATTACHED DOCUMENTS FOR EACH WELL

#### **Casing and Cementing notes:**

1. All cement volumes are typical, actual conditions may dictate changes in geometry.
2. All casing and cement meet API standards, but are not API monogrammed.
3. Mine strings will be run as required by geologic conditions.
4. Full BOP pressure tests on installation, function test daily, blind ram test on trips.

### **Flaring Activities**

*See also Section VII: Flaring for additional information and details.*

RECEIVED  
Office of Oil and Gas

 DEC 20 2019

WV Department of  
Environmental Protection

DEC 20 2019

Well **516228(OXF43H20)**  
EQT Production  
Oxford Quad  
Doddridge County, WV

WV Department of  
Environmental Protection  
Azimuth **336**  
Vertical Section **7199**  
Enertia # **516228(OXF43H20)**

Note: Diagram is not to scale

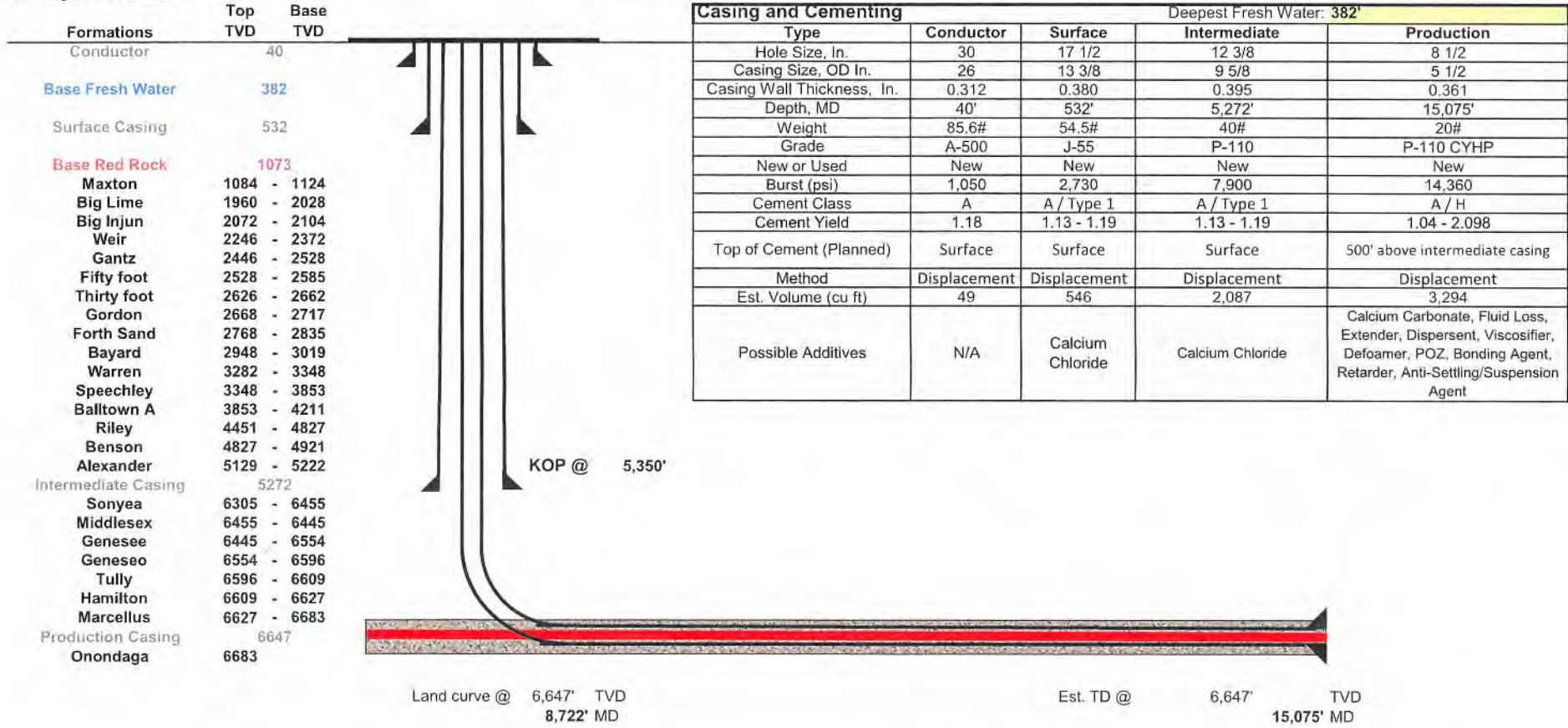

Proposed Well Work:  
Drill and complete a new horizontal well in the Marcellus formation.  
Drill the vertical to an approximate depth of 5350'.  
Kick off and drill curve. Drill lateral in the Marcellus. Cement casing.

DEC 20 2019

Well 516229(OXF43H21)  
EQT Production  
Oxford Quad  
Doddridge County, WV

WV Department of  
Environmental Protection  
Azimuth 155  
Vertical Section 13989  
Enertia # 516229(OXF43H21)

Note: Diagram is not to scale

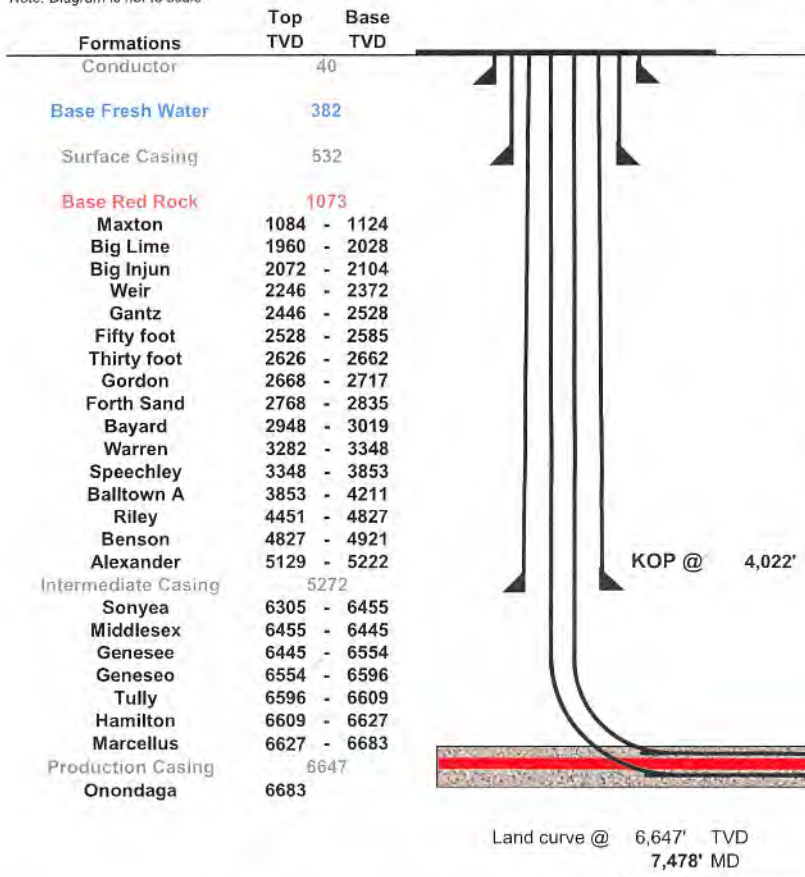

Casing and Cementing				Deepest Fresh Water: 382'
Type	Conductor	Surface	Intermediate	Production
Hole Size, In.	30	17 1/2	12 3/8	8 1/2
Casing Size, OD In.	26	13 3/8	9 5/8	5 1/2
Casing Wall Thickness, In.	0.312	0.380	0.395	0.361
Depth, MD	40'	532'	5,272'	20,344'
Weight	85.6#	54.5#	40#	20#
Grade	A-500	J-55	P-110	P-110 CYHP
New or Used	New	New	New	New
Burst (psi)	1,050	2,730	7,900	14,360
Cement Class	A	A / Type 1	A / Type 1	A / H
Cement Yield	1.18	1.13 - 1.19	1.13 - 1.19	1.04 - 2.098
Top of Cement (Planned)	Surface	Surface	Surface	500' above intermediate casing
Method	Displacement	Displacement	Displacement	Displacement
Est. Volume (cu ft)	49	546	2,087	4,622
Possible Additives	N/A	Calcium Chloride	Calcium Chloride	Calcium Carbonate, Fluid Loss, Extender, Dispersent, Viscosifier, Defoamer, POZ, Bonding Agent, Retarder, Anti-Settling/Suspension Agent

Proposed Well Work:  
 Drill and complete a new horizontal well in the Marcellus formation.  
 Drill the vertical to an approximate depth of 4022'.  
 Kick off and drill curve. Drill lateral in the Marcellus. Cement casing.

12,866' Lateral

DEC 20 2019

Well 516230(OXF43H22)  
EQT Production  
Oxford Quad  
Doddridge County, WV

WV Department of  
Environmental Protection

Azimuth 336  
Vertical Section 4681  
Enertia # 516230(OXF43H22)

Note: Diagram is not to scale

Formations	Top TVD	Base TVD
Conductor	40	
Base Fresh Water	382	
Surface Casing	532	
Base Red Rock	1073	
Maxton	1084 - 1124	
Big Lime	1960 - 2028	
Big Injun	2072 - 2104	
Weir	2246 - 2372	
Gantz	2446 - 2528	
Fifty foot	2528 - 2585	
Thirty foot	2626 - 2662	
Gordon	2668 - 2717	
Forth Sand	2768 - 2835	
Bayard	2948 - 3019	
Warren	3282 - 3348	
Speechley	3348 - 3853	
Balltown A	3853 - 4211	
Riley	4451 - 4827	
Benson	4827 - 4921	
Alexander	5129 - 5222	
Intermediate Casing	5272	
Sonyea	6305 - 6455	
Middlesex	6455 - 6445	
Genesee	6445 - 6554	
Geneseo	6554 - 6596	
Tully	6596 - 6609	
Hamilton	6609 - 6627	
Marcellus	6627 - 6683	
Production Casing	6647	
Onondaga	6683	

Casing and Cementing				Deepest Fresh Water: 382'
Type	Conductor	Surface	Intermediate	Production
Hole Size, In.	30	17 1/2	12 3/8	8 1/2
Casing Size, OD In.	26	13 3/8	9 5/8	5 1/2
Casing Wall Thickness, In.	0.312	0.380	0.395	0.361
Depth, MD	40'	532'	5,272'	12,057'
Weight	85.6#	54.5#	40#	20#
Grade	A-500	J-55	P-110	P-110 CYHP
New or Used	New	New	New	New
Burst (psi)	1,050	2,730	7,900	14,360
Cement Class	A	A / Type 1	A / Type 1	A / H
Cement Yield	1.18	1.13 - 1.19	1.13 - 1.19	1.04 - 2.098
Top of Cement (Planned)	Surface	Surface	Surface	500' above intermediate casing
Method	Displacement	Displacement	Displacement	Displacement
Est. Volume (cu ft)	49	546	2,087	2,533
Possible Additives	N/A	Calcium Chloride	Calcium Chloride	Calcium Carbonate, Fluid Loss Extender, Dispersent, Viscosifier, Defoamer, POZ, Bonding Agent, Retarder, Anti-Settling/Suspension Agent

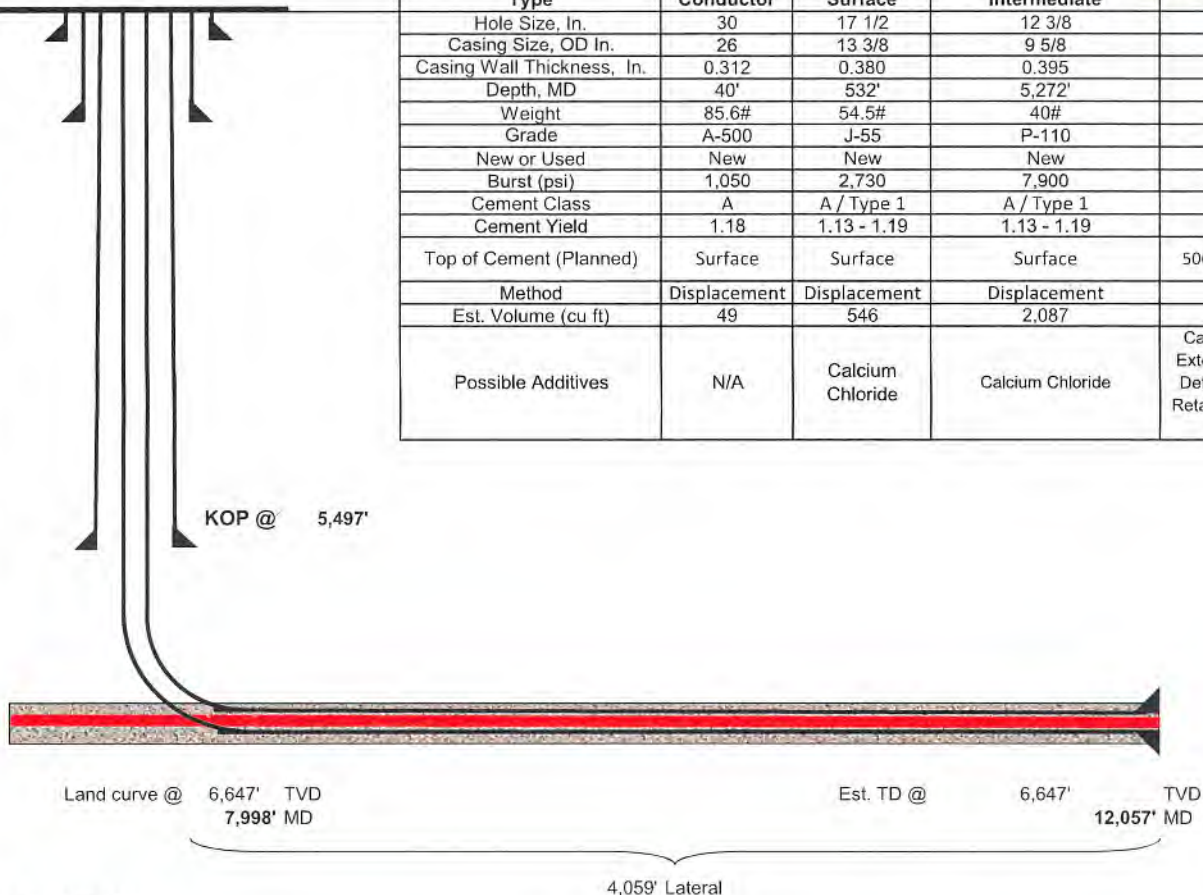

Proposed Well Work:

Drill and complete a new horizontal well in the Marcellus formation.  
Drill the vertical to an approximate depth of 5497'.  
Kick off and drill curve. Drill lateral in the Marcellus. Cement casing.



DEC 20 2019

Well 516232(OXF43H24)  
EQT Production  
Oxford Quad  
Doddridge County, WV

WV Department of  
Environmental Protection

Azimuth 155  
Vertical Section 13472  
Enertia # 516232(OXF43H24)

Note: Diagram is not to scale

Formations	Top TVD	Base TVD
Conductor	40	
Base Fresh Water	382	
Surface Casing	532	
Base Red Rock	1073	
Maxton	1084 - 1124	
Big Lime	1960 - 2028	
Big Injun	2072 - 2104	
Weir	2246 - 2372	
Gantz	2446 - 2528	
Fifty foot	2528 - 2585	
Thirty foot	2626 - 2662	
Gordon	2668 - 2717	
Forth Sand	2768 - 2835	
Bayard	2948 - 3019	
Warren	3282 - 3348	
Speechley	3348 - 3853	
Balltown A	3853 - 4211	
Riley	4451 - 4827	
Benson	4827 - 4921	
Alexander	5129 - 5222	
Intermediate Casing	5272	
Sonyea	6305 - 6455	
Middlesex	6455 - 6445	
Genesee	6445 - 6554	
Geneseo	6554 - 6596	
Tully	6596 - 6609	
Hamilton	6609 - 6627	
Marcellus	6627 - 6683	
Production Casing	6647	
Onondaga	6683	

Casing and Cementing				Deepest Fresh Water: 382'
Type	Conductor	Surface	Intermediate	Production
Hole Size, In.	30	17 1/2	12 3/8	8 1/2
Casing Size, OD In.	26	13 3/8	9 5/8	5 1/2
Casing Wall Thickness, In.	0.312	0.380	0.395	0.361
Depth, MD	40'	532'	5,272'	20,116'
Weight	85.6#	54.5#	40#	20#
Grade	A-500	J-55	P-110	P-110 CYHP
New or Used	New	New	New	New
Burst (psi)	1,050	2,730	7,900	14,360
Cement Class	A	A / Type 1	A / Type 1	A / H
Cement Yield	1.18	1.13 - 1.19	1.13 - 1.19	1.04 - 2.098
Top of Cement (Planned)	Surface	Surface	Surface	500' above intermediate casing
Method	Displacement	Displacement	Displacement	Displacement
Est. Volume (cu ft)	49	546	2,087	4,564
Possible Additives	N/A	Calcium Chloride	Calcium Chloride	Calcium Carbonate, Fluid Loss, Extender, Dispersent, Viscosifier, Defoamer, POZ, Bonding Agent, Retarder, Anti-Settling/Suspension Agent

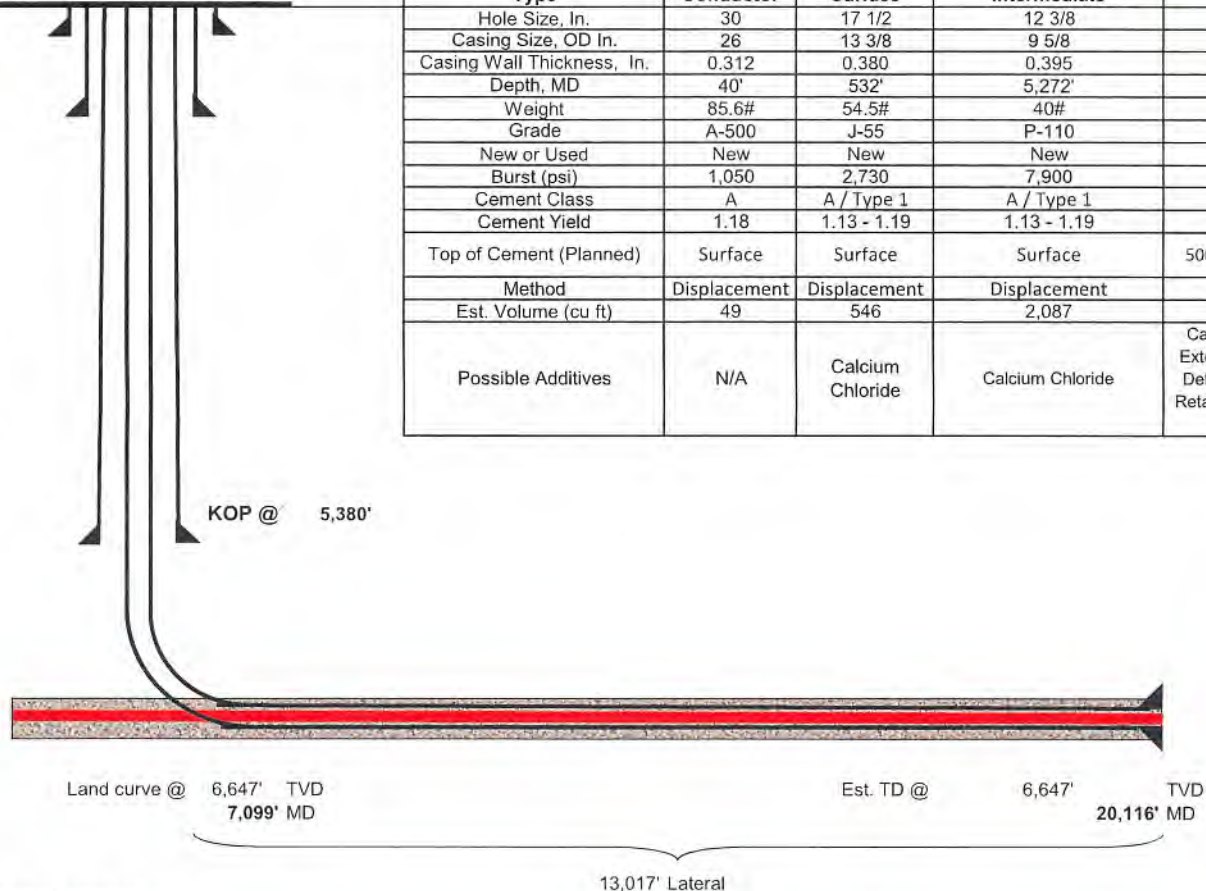

Proposed Well Work:

Drill and complete a new horizontal well in the Marcellus formation.  
Drill the vertical to an approximate depth of 5380'.  
Kick off and drill curve. Drill lateral in the Marcellus. Cement casing.

RECEIVED  
Office of Oil and Gas

DEC 20 2019

WV Department of  
Environmental Protection

Azimuth 336  
Vertical Section 5905

Enertia # 516238(OXF43H30)

Well 516238(OXF43H30)  
EQT Production  
Oxford Quad  
Doddridge County, WV

Note: Diagram is not to scale

Formations	Top TVD	Base TVD
Conductor	40	
Base Fresh Water	382	
Surface Casing	532	
Base Red Rock	1073	
Maxton	1084 - 1124	
Big Lime	1960 - 2028	
Big Injun	2072 - 2104	
Weir	2246 - 2372	
Gantz	2446 - 2528	
Fifty foot	2528 - 2585	
Thirty foot	2626 - 2662	
Gordon	2668 - 2717	
Forth Sand	2768 - 2835	
Bayard	2948 - 3019	
Warren	3282 - 3348	
Speechley	3348 - 3853	
Balltown A	3853 - 4211	
Riley	4451 - 4827	
Benson	4827 - 4921	
Alexander	5129 - 5222	
Intermediate Casing	5272	
Sonyea	6305 - 6455	
Middlesex	6455 - 6445	
Genesee	6445 - 6554	
Geneseo	6554 - 6596	
Tully	6596 - 6609	
Hamilton	6609 - 6627	
Marcellus	6627 - 6683	
Production Casing	6647	
Onondaga	6683	

Casing and Cementing				Deepest Fresh Water: 382'
Type	Conductor	Surface	Intermediate	Production
Hole Size, In.	30	17 1/2	12 3/8	8 1/2
Casing Size, OD In.	26	13 3/8	9 5/8	5 1/2
Casing Wall Thickness, In.	0.312	0.380	0.395	0.361
Depth, MD	40'	532'	5,272'	12,421'
Weight	85.6#	54.5#	40#	20#
Grade	A-500	J-55	P-110	P-110 CYHP
New or Used	New	New	New	New
Burst (psi)	1,050	2,730	7,900	14,360
Cement Class	A	A / Type 1	A / Type 1	A / H
Cement Yield	1.18	1.13 - 1.19	1.13 - 1.19	1.04 - 2.098
Top of Cement (Planned)	Surface	Surface	Surface	500' above intermediate casing
Method	Displacement	Displacement	Displacement	Displacement
Est. Volume (cu ft)	49	546	2,087	2,625
Possible Additives	N/A	Calcium Chloride	Calcium Chloride	Calcium Carbonate, Fluid Loss, Extender, Dispersent, Viscosifier, Defoamer, POZ, Bonding Agent, Retarder, Anti-Settling/Suspension Agent

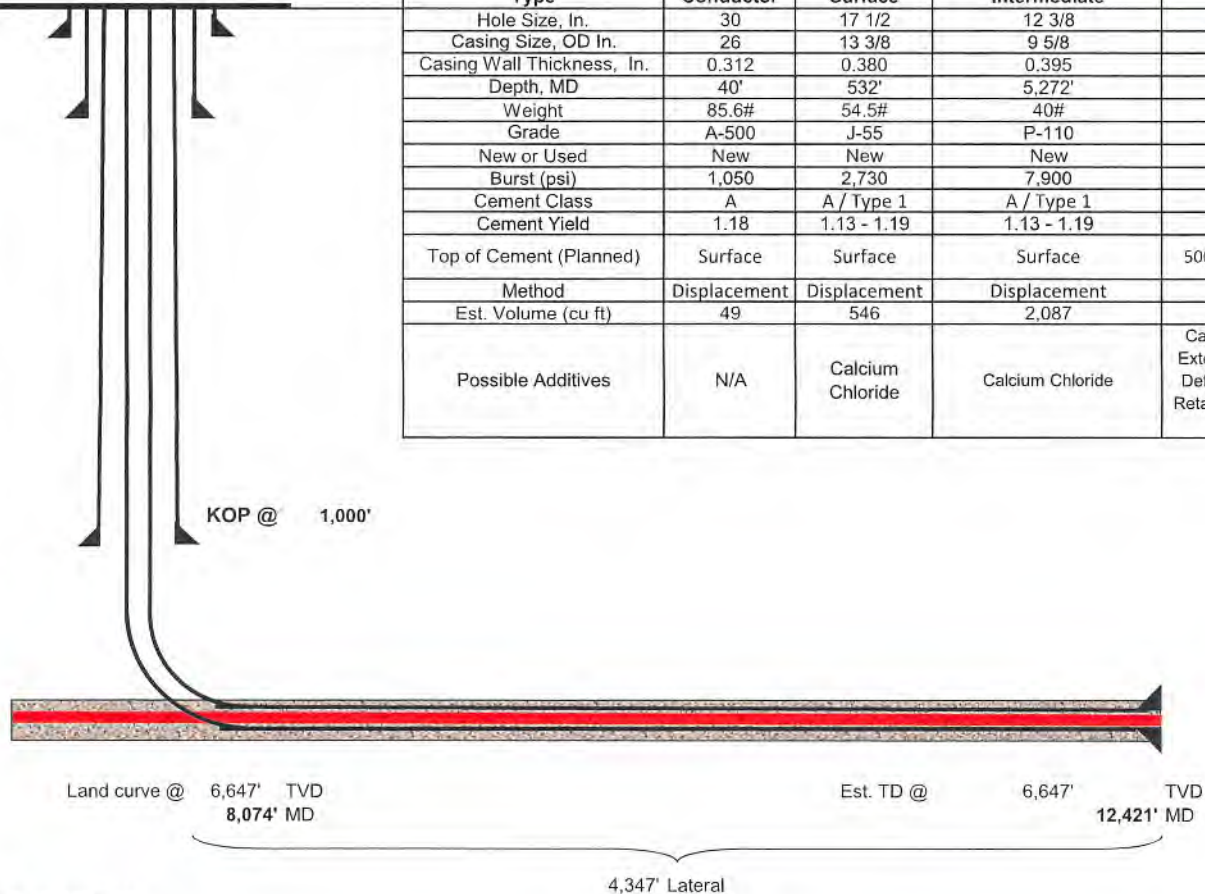

Proposed Well Work:

Drill and complete a new horizontal well in the Marcellus formation.  
Drill the vertical to an approximate depth of 1000'.  
Kick off and drill curve. Drill lateral in the Marcellus. Cement casing.

RECEIVED  
Office of Oil and Gas

DEC 20 2019

Well 516240(OXF43H31)

EQT Production  
Oxford Quad  
Doddridge County, WV

WV Department of  
Environmental Protection

Azimuth 336  
Vertical Section 11341

Enertia # 516240(OXF43H31)

Note: Diagram is not to scale

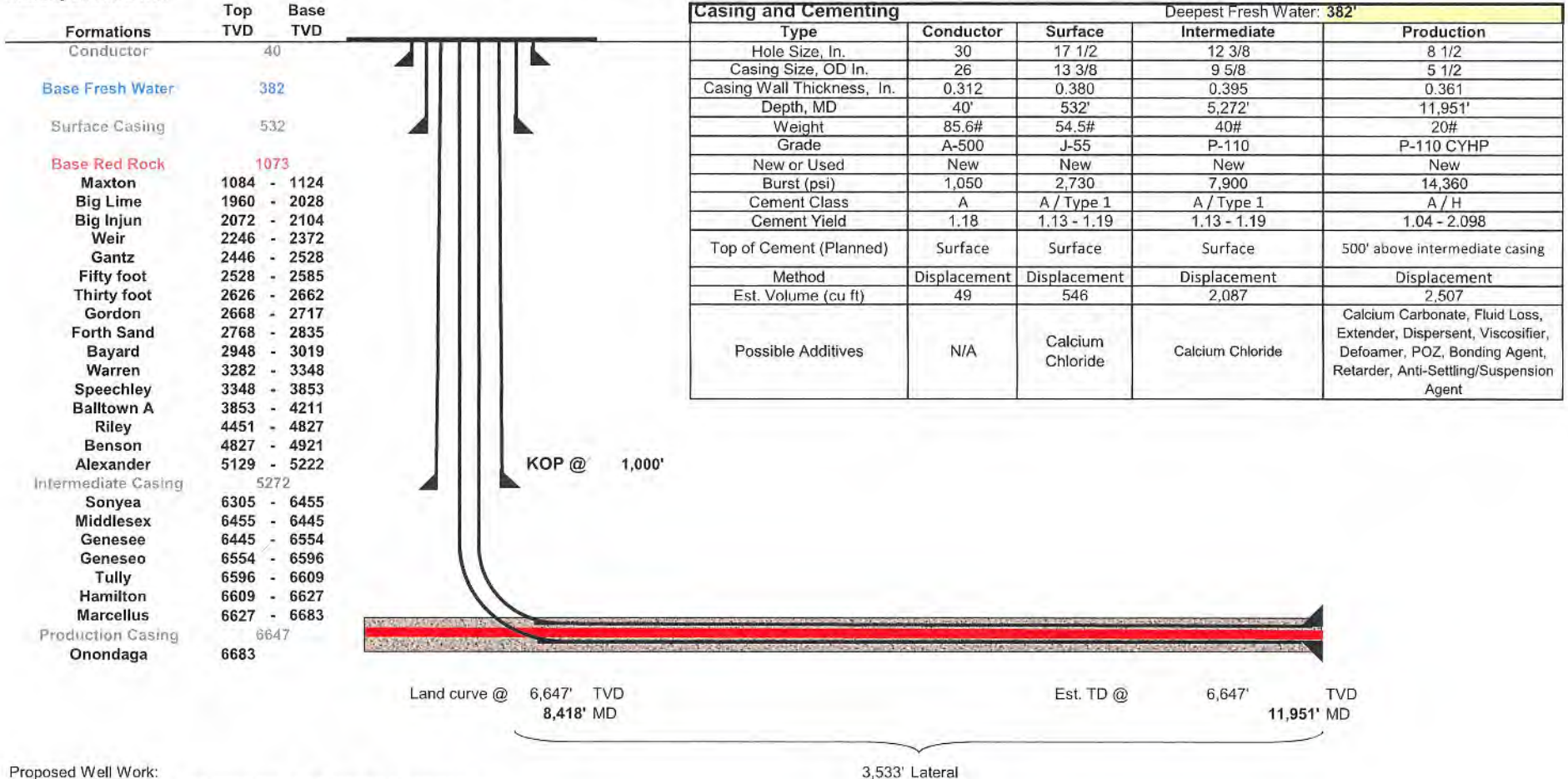

Proposed Well Work:

Drill and complete a new horizontal well in the Marcellus formation.  
Drill the vertical to an approximate depth of 1000'.  
Kick off and drill curve. Drill lateral in the Marcellus. Cement casing.

DEC 20 2019

Well 516241(OXF43H32)  
EQT Production  
Oxford Quad  
Doddridge County, WV

WV Department of  
Environmental Protection  
Azimuth 155  
Vertical Section 15472  
Enertia # 516241(OXF43H32)

Note: Diagram is not to scale

Formations	Top TVD	Base TVD
Conductor	-40	
Base Fresh Water	382	
Surface Casing	532	
Base Red Rock	1073	
Maxton	1084 - 1124	
Big Lime	1960 - 2028	
Big Injun	2072 - 2104	
Weir	2246 - 2372	
Gantz	2446 - 2528	
Fifty foot	2528 - 2585	
Thirty foot	2626 - 2662	
Gordon	2668 - 2717	
Forth Sand	2768 - 2835	
Bayard	2948 - 3019	
Warren	3282 - 3348	
Speechley	3348 - 3853	
Balltown A	3853 - 4211	
Riley	4451 - 4827	
Benson	4827 - 4921	
Alexander	5129 - 5222	
Intermediate Casing	5272	
Sonyea	6305 - 6455	
Middlesex	6455 - 6445	
Genesee	6445 - 6554	
Geneseo	6554 - 6596	
Tully	6596 - 6609	
Hamilton	6609 - 6627	
Marcellus	6627 - 6683	
Production Casing	6647	
Onondaga	6683	

Casing and Cementing				Deepest Fresh Water: 382'
Type	Conductor	Surface	Intermediate	Production
Hole Size, In.	30	17 1/2	12 3/8	8 1/2
Casing Size, OD In.	26	13 3/8	9 5/8	5 1/2
Casing Wall Thickness, In.	0.312	0.380	0.395	0.361
Depth, MD	40'	532'	5,272'	21,399'
Weight	85.6#	54.5#	40#	20#
Grade	A-500	J-55	P-110	P-110 CYHP
New or Used	New	New	New	New
Burst (psi)	1,050	2,730	7,900	14,360
Cement Class	A	A / Type 1	A / Type 1	A / H
Cement Yield	1.18	1.13 - 1.19	1.13 - 1.19	1.04 - 2.098
Top of Cement (Planned)	Surface	Surface	Surface	500' above intermediate casing
Method	Displacement	Displacement	Displacement	Displacement
Est. Volume (cu ft)	49	546	2,087	4,888
Possible Additives	N/A	Calcium Chloride	Calcium Chloride	Calcium Carbonate, Fluid Loss Extender, Dispersent, Viscosifier, Defoamer, POZ, Bonding Agent, Retarder, Anti-Settling/Suspension Agent

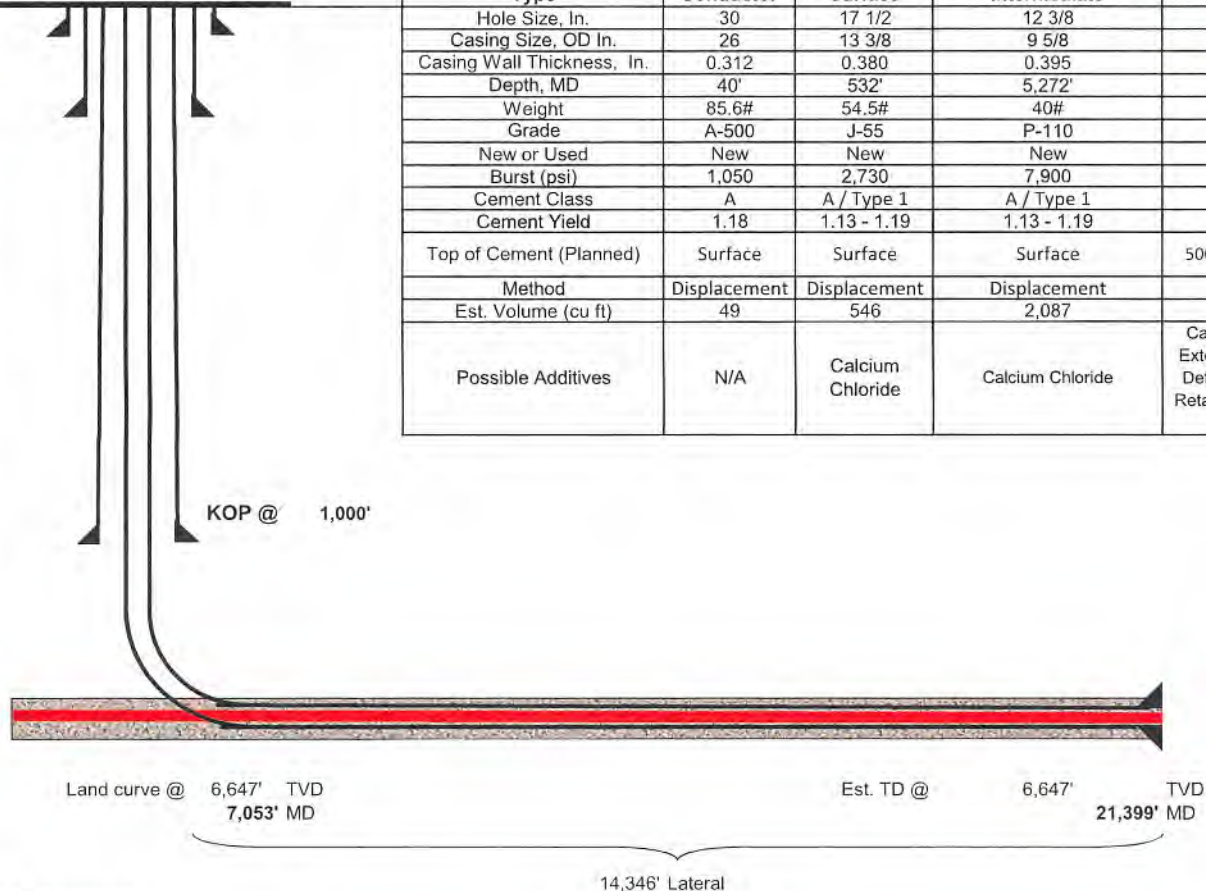

Proposed Well Work:

- Drill and complete a new horizontal well in the Marcellus formation.
- Drill the vertical to an approximate depth of 1000'.
- Kick off and drill curve. Drill lateral in the Marcellus. Cement casing.

14,346' Lateral

DEC 20 2019

Well 516243(OXF43H34)  
EQT Production  
Oxford Quad  
Doddridge County, WV

WV Department of  
Environmental Protection

Azimuth 155  
Vertical Section 11900  
Enertia # 516243(OXF43H34)

Note: Diagram is not to scale

Formations	Top TVD	Base TVD
Conductor	40	
Base Fresh Water	382	
Surface Casing	532	
Base Red Rock	1073	
Maxton	1084 - 1124	
Big Lime	1960 - 2028	
Big Injun	2072 - 2104	
Weir	2246 - 2372	
Gantz	2446 - 2528	
Fifty foot	2528 - 2585	
Thirty foot	2626 - 2662	
Gordon	2668 - 2717	
Forth Sand	2768 - 2835	
Bayard	2948 - 3019	
Warren	3282 - 3348	
Speechley	3348 - 3853	
Balltown A	3853 - 4211	
Riley	4451 - 4827	
Benson	4827 - 4921	
Alexander	5129 - 5222	
Intermediate Casing	5272	
Sonyea	6305 - 6455	
Middlesex	6455 - 6445	
Genesee	6445 - 6554	
Geneseo	6554 - 6596	
Tully	6596 - 6609	
Hamilton	6609 - 6627	
Marcellus	6627 - 6683	
Production Casing	6647	
Onondaga	6683	

Casing and Cementing				Deepest Fresh Water: 382'
Type	Conductor	Surface	Intermediate	Production
Hole Size, In.	30	17 1/2	12 3/8	8 1/2
Casing Size, OD In.	26	13 3/8	9 5/8	5 1/2
Casing Wall Thickness, In.	0.312	0.380	0.395	0.361
Depth, MD	40'	532'	5,272'	18,157'
Weight	85.6#	54.5#	40#	20#
Grade	A-500	J-55	P-110	P-110 CYHP
New or Used	New	New	New	New
Burst (psi)	1,050	2,730	7,900	14,360
Cement Class	A	A / Type 1	A / Type 1	A / H
Cement Yield	1.18	1.13 - 1.19	1.13 - 1.19	1.04 - 2.098
Top of Cement (Planned)	Surface	Surface	Surface	500' above intermediate casing
Method	Displacement	Displacement	Displacement	Displacement
Est. Volume (cu ft)	49	546	2,087	4,071
Possible Additives	N/A	Calcium Chloride	Calcium Chloride	Calcium Carbonate, Fluid Loss, Extender, Dispersent, Viscosifier, Defoamer, POZ, Bonding Agent, Retarder, Anti-Settling/Suspension Agent

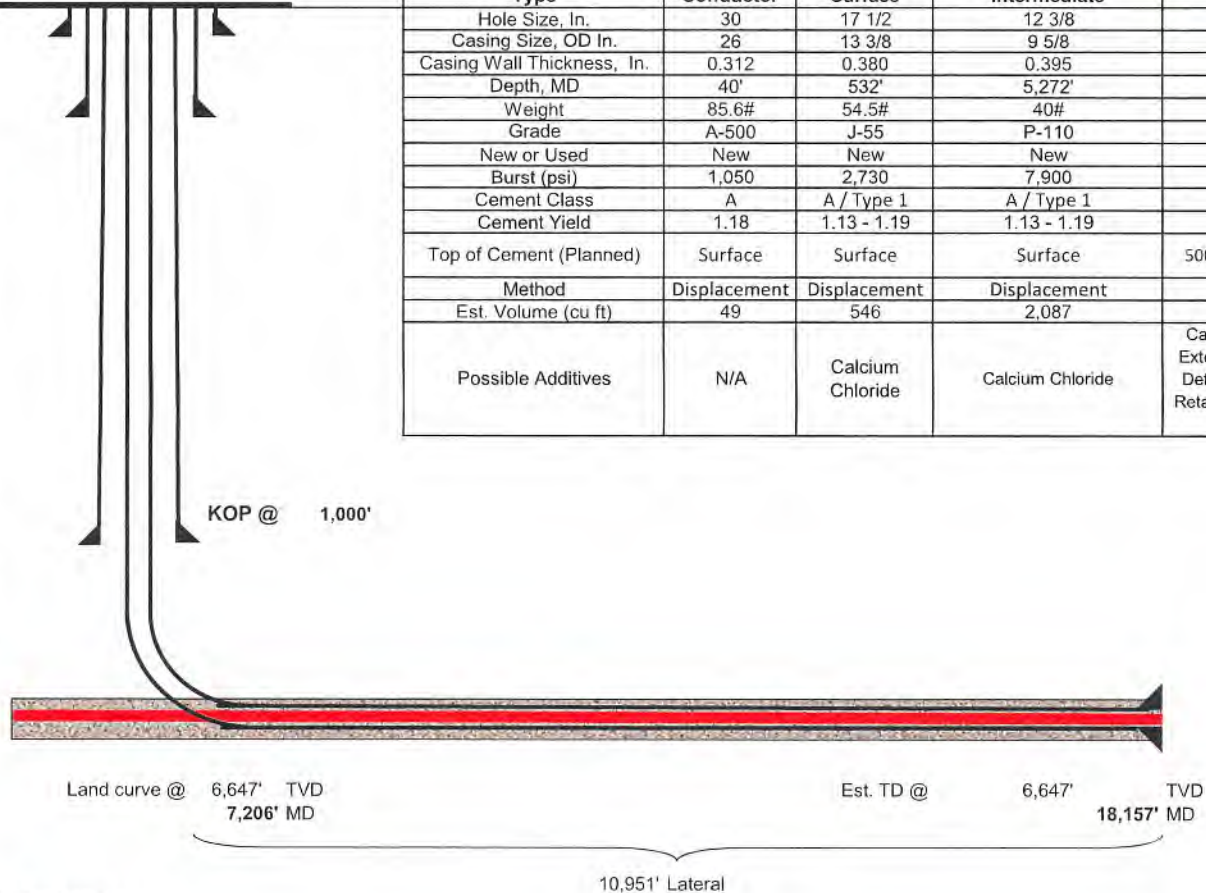

Proposed Well Work:

Drill and complete a new horizontal well in the Marcellus formation.  
Drill the vertical to an approximate depth of 1000'.  
Kick off and drill curve. Drill lateral in the Marcellus. Cement casing.

DEC 20 2019

Well **516244 (OXF43H35)**  
EQT Production  
Oxford Quad  
Doddridge County, WV

WV Department of  
Environmental Protection

Azimuth 055  
Vertical Section 12368

Enertia # 516244 (OXF43H35)

Note: Diagram is not to scale

Formations	Top TVD	Base TVD
Conductor	40	
Base Fresh Water	382	
Surface Casing	532	
Base Red Rock	1073	
Maxton	1084 - 1124	
Big Lime	1960 - 2028	
Big Injun	2072 - 2104	
Weir	2246 - 2372	
Gantz	2446 - 2528	
Fifty foot	2528 - 2585	
Thirty foot	2626 - 2662	
Gordon	2668 - 2717	
Forth Sand	2768 - 2835	
Bayard	2948 - 3019	
Warren	3282 - 3348	
Speechley	3348 - 3853	
Balltown A	3853 - 4211	
Riley	4451 - 4827	
Benson	4827 - 4921	
Alexander	5129 - 5222	
Intermediate Casing	5272	
Sonyea	6305 - 6455	
Middlesex	6455 - 6445	
Genesee	6445 - 6554	
Geneseo	6554 - 6596	
Tully	6596 - 6609	
Hamilton	6609 - 6627	
Marcellus	6627 - 6683	
Production Casing	6647	
Onondaga	6683	

Casing and Cementing				Deepest Fresh Water: 382'
Type	Conductor	Surface	Intermediate	Production
Hole Size, In.	30	17 1/2	12 3/8	8 1/2
Casing Size, OD In.	26	13 3/8	9 5/8	5 1/2
Casing Wall Thickness, In.	0.312	0.380	0.395	0.361
Depth, MD	40'	532'	5,272'	18,794'
Weight	85.6#	54.5#	40#	20#
Grade	A-500	J-55	P-110	P-110 CYHP
New or Used	New	New	New	New
Burst (psi)	1,050	2,730	7,900	14,360
Cement Class	A	A / Type 1	A / Type 1	A / H
Cement Yield	1.18	1.13 - 1.19	1.13 - 1.19	1.04 - 2.098
Top of Cement (Planned)	Surface	Surface	Surface	500' above intermediate casing
Method	Displacement	Displacement	Displacement	Displacement
Est. Volume (cu ft)	49	546	2,087	4,231
Possible Additives	N/A	Calcium Chloride	Calcium Chloride	Calcium Carbonate, Fluid Loss, Extender, Dispersent, Viscosifier, Defoamer, POZ, Bonding Agent, Retarder, Anti-Settling/Suspension Agent

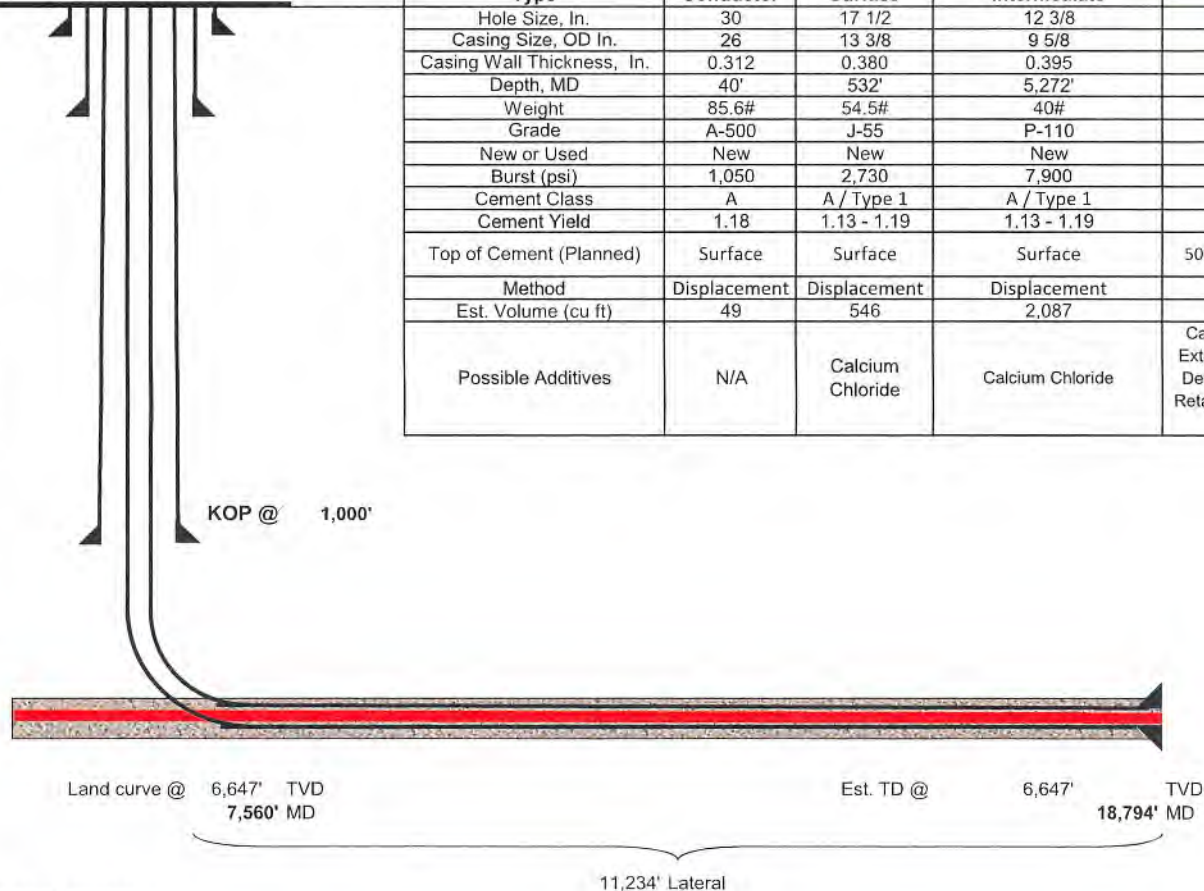

Proposed Well Work:

Drill and complete a new horizontal well in the Marcellus formation.  
Drill the vertical to an approximate depth of 1000'.  
Kick off and drill curve. Drill lateral in the Marcellus. Cement casing.

**WEST VIRGINIA GEOLOGICAL PROGNOSIS**

Horizontal Well  
OXF43H30

516238(OXF43H30)

**Drilling Objectives:**

**County:** Marcellus  
**Quad:** Doddridge  
 Oxford  
**Elevation:** 1242 KB 1229 GL (As-Built)  
**Surface location** Northing: 241902.39 Easting: 1633402.15  
**Landing Point** Northing: 241820.78 Easting: 1629095.40  
**Toe location** Northing: 250051.23 Easting: 1625527.70  
**Recommended Azimuth** 0 Degrees

TVD: 6647  
 Recommended LP to TD: 0,000'

**Recommended Gas Tests:** 1800, 2050, 2600, Intm Csg. Pt., 3400, 4900, 5250, KOP. (Gas test at any mine void)  
 Gas test during any irtp or significant downtime while drilling the lateral section.

**ESTIMATED FORMATION TOPS**

Determined from OXF43 and OXF45 Pilot Hole Logs

Formation	Top (TVD)	Base (TVD)	Lithology	Comments	Top RR	Base RR
Fresh Water Zone	1	382		FW @ 70,221,307,382...	21	41
Waynesburg A	321	322	Coal	No past, present, or permitted mining.	123	179
Maxton	1084	1124	Sandstone	No SW present in shallow offset wells.	181	211
Big Lime	1960	2028	Limestone		266	411
Big Injun	2072	2104	Sandstone	Storage is NOT of concern at this location	361	451
Weir	2246	2372	Sandstone		462	532
Top Devonian	2446				561	716
Gantz	2446	2528	Silty Sand		706	829
Fifty foot	2528	2585	Silty Sand		956	1073
Thirty foot	2626	2662	Silty Sand			Base of Red Rock
Gordon	2668	2717	Silty Sand			
Forth Sand	2768	2835	Silty Sand			
Bayard	2948	3019	Silty Sand			
Warren	3282	3348	Silty Sand			
Spechtley	3348	3853	Silty Sand			
Balltown A	3853	4211	Silty Sand			
Riley	4451	4827	Silty Sand			
Benson	4827	4921	Silty Sand			
Alexander	5129	5222	Silty Sand	Base of Offset Well Perforations at 5207' TVD		
Int. csg pt	5272					
Elks	5222	6305	Gray Shales and Silts			
Sonyea	6305	6455	Gray shale			
Middlesex	6455	6445	Shale			
Genesee	6445	6554	Gray shale interbedded			
Genesee	6554	6596	Black Shale			
Tully	6596	6609	Limestone			
Hamilton	6609	6627	Gray shale with some			
Marcellus	6627	6683	Black Shale			
Purcell	6658	6661	Limestone			
-Lateral Zone	6647			Start Lateral at 6647'		
Cherry Valley	6667	6670	Limestone			
Onondaga	6683		Limestone			

Target Thickness	57 feet
Max Anticipated Rock Pressure	2951 PSI

**Comments:**

Note that this is a TVD prog for a horizontal well (azimuth of 0 degrees; target formation = Marcellus). All measurements taken from estimated KB elevation. Water and coal information estimated from surrounding well data.  
 Intermediate casing point is recommended 50' beneath the Alexander to shut off any water production from the Upper Devonian sands. Intermediate casing should be cemented into the surface string, per WV regulations.  
 The estimated landing point TVD is 6647'. Rig geologist may adjust landing point. After the well is landed, drill to reported bed dips/ geologists' recommendation. The geologic structure is unknown at this time.

**RECOMMENDED CASING POINTS**

<b>Fresh Water/Coal</b>	CSG OD	13 3/8	CSG DEPTH:	532	150' below freshwater
<b>Intermediate 1:</b>	CSG OD	9 5/8	CSG DEPTH:	5272	50' below Alexander
<b>Production:</b>	CSG OD	5 1/2	CSG DEPTH:	@ TD	

RECEIVED  
Office of Oil and Gas

DEC 20 2019

WV Department of  
Environmental Protection



Where energy meets innovation.™

### WELL SITE SAFETY PLAN RECEIPT ACKNOWLEDGMENT

This form letter is to be signed by the LEPC or CES representative to indicate they have received the Site Safety Plan for the following well site location and understand its use.

**Site Location:**

WV – Doddridge – West Union  
Site State, County and Municipality

EQT OXF43 Pad  
Site Location Designation

3731 Grove Summers Rd. West Union, WV 26456  
Site Address assigned by County 9-1-1

S Fork of Hughes River  
Nearest cross road(s)

39.180296, -80.797064  
Access Road Coordinates

39.157175, -80.792576  
Pad Site Coordinates

I have received my copy of the *Well Site Safety Plan* for the above described location. I understand that this is a reference tool for emergency response and it is my responsibility to read and understand the Plan.

\_\_\_\_\_  
LCEP or CES Representative (printed)

\_\_\_\_\_  
EQT Representative (printed)

\_\_\_\_\_  
Representative Affiliation and Title

\_\_\_\_\_  
EQT Representative Title

\_\_\_\_\_  
Representative Signature

\_\_\_\_\_  
EQT Representative Signature

\_\_\_\_\_  
Date

\_\_\_\_\_  
Date

RECEIVED  
Office of Oil and Gas

DEC 20 2019

WV Department of  
Environmental Protection



**OXF43H34**  
**OXF43**  
**EQT Production Company**

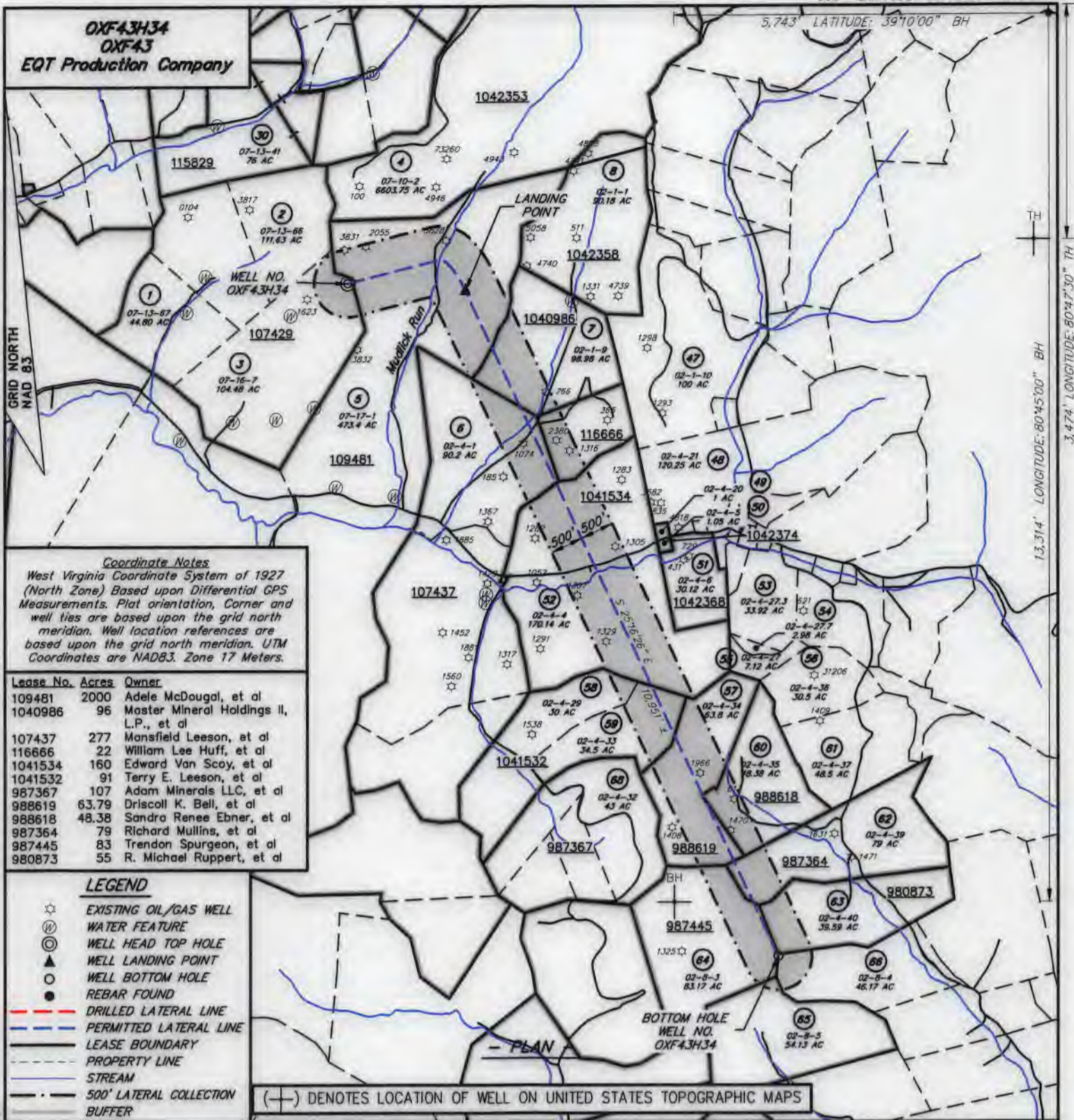

**Coordinate Notes**

West Virginia Coordinate System of 1927 (North Zone) Based upon Differential GPS Measurements. Plat orientation, Corner and well ties are based upon the grid north meridian. Well location references are based upon the grid north meridian. UTM Coordinates are NAD83, Zone 17 Meters.

Lease No.	Acres	Owner
109481	2000	Adele McDougal, et al
1040986	96	Master Mineral Holdings II, L.P., et al
107437	277	Mansfield Leeson, et al
116666	22	William Lee Huff, et al
1041534	160	Edward Van Scoy, et al
1041532	91	Terry E. Leeson, et al
987367	107	Adam Minerals LLC, et al
988619	63.79	Driscoll K. Bell, et al
988618	48.38	Sandra Renee Ebner, et al
987364	79	Richard Mullins, et al
987445	83	Trendon Spurgeon, et al
980873	55	R. Michael Ruppert, et al

**LEGEND**

- ☆ EXISTING OIL/GAS WELL
- ⊙ WATER FEATURE
- ⊙ WELL HEAD TOP HOLE
- ▲ WELL LANDING POINT
- WELL BOTTOM HOLE
- REBAR FOUND
- DRILLED LATERAL LINE
- PERMITTED LATERAL LINE
- LEASE BOUNDARY
- PROPERTY LINE
- STREAM
- 500' LATERAL COLLECTION BUFFER

(+) DENOTES LOCATION OF WELL ON UNITED STATES TOPOGRAPHIC MAPS



I, THE UNDERSIGNED, HEREBY CERTIFY THAT THIS PLAT IS CORRECT TO THE BEST OF MY KNOWLEDGE AND BELIEF AND SHOWS ALL THE INFORMATION REQUIRED BY LAW AND REGULATIONS ISSUED AND PRESCRIBED BY THE DEPARTMENT OF ENVIRONMENTAL PROTECTION.

*[Handwritten Signature]*



FILE NO.: EES-60635  
DRAWING NO.: OXF43\_Well Plat  
SCALE: 1" = 2000'  
MINIMUM DEGREE OF ACCURACY: ±3'  
PROVEN SOURCE OF ELEVATION: GPS

**STATE OF WEST VIRGINIA**  
**DEPARTMENT OF ENVIRONMENTAL PROTECTION**  
**OFFICE OF OIL AND GAS**

DATE DECEMBER 15, 20 19  
OPERATORS  
WELL NO. OXF43H34  
API WELL NO. MOD  
47 017 06885  
STATE COUNTY PERMIT

WELL TYPE:  OIL  GAS  LIQUID INJECTION  WASTE DISPOSAL  (IF GAS) PRODUCTION:  STORAGE  DEEP  SHALLOW  
LOCATION, ELEVATION: 1229' (As-Built Pad) WATERSHED: Middle Fork Hughes River QUADRANGLE: OXFORD  
DISTRICT: SOUTH WEST / COVE COUNTY: DODDRIDGE  
SURFACE OWNER: Cathy Jean Wetzel, ET AL ACREAGE: 104.48± AC  
ROYALTY OWNER: Franklin Maxwell Heirs L. P. LEASE NO.: 107429 ACREAGE: 255± AC  
PROPOSED WORK:  DRILL  CONVERT  DRILL DEEPER  FRACTURE OR STIMULATE  PLUG OFF OLD FORMATION  
 PERFORATE NEW FORMATION  OTHER PHYSICAL CHANGE IN WELL (SPECIFY)  
 PLUG AND ABANDON  CLEAN OUT AND REPLUG TARGET FORMATION: MARCELLUS ESTIMATED DEPTH: 6,647'

WELL OPERATOR: EQT Production Company DESIGNATED AGENT: Joseph C. Mallow  
ADDRESS: 400 Woodcliff Drive ADDRESS: 115 Professional Pl. P.O. Box 280  
Canonsburg, PA 15317 Bridgeport, WV 26330

WWW.ENCOMPASSSERVICES.COM PLOT DATE: 12/15/2019 CAD FILE: OXF\_43\_WELL\_PLAT-2019-11-27.DWG

**OXF43H34**  
**OXF43**  
**EQT Production Company**

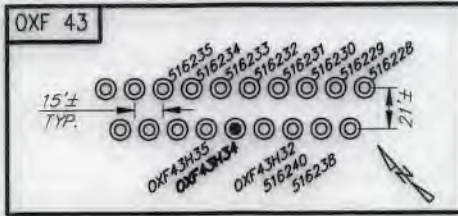

**OXF43H34 Well Point Coordinates**

Top Hole Coordinates		
NAD 27 S.P.C. (Ft.)	N: 241,942.484	E: 1,633,357.514
NAD 27 GEO	LAT: 39.157030	LONG: 80.792963
NAD 83 UTM 17N (M)	N: 4,334,232.6	E: 517,903.0
NAD 83 S.P.C. (Ft.)	N: 241,977.8	E: 1,601,916.7

Landing Point Coordinates		
NAD 27 S.P.C. (Ft.)	N: 241,836.607	E: 1,635,119.885
NAD 27 GEO	LAT: 39.156809	LONG: 80.786743
NAD 83 UTM 17N (M)	N: 4,334,209.3	E: 518,440.4
NAD 83 S.P.C. (Ft.)	N: 241,872.0	E: 1,603,679.1

Bottom Hole Coordinates		
NAD 27 S.P.C. (Ft.)	N: 231,934.160	E: 1,639,795.040
NAD 27 GEO	LAT: 39.129806	LONG: 80.769765
NAD 83 UTM 17N (M)	N: 4,331,216.4	E: 519,915.0
NAD 83 S.P.C. (Ft.)	N: 231,969.7	E: 1,608,354.3

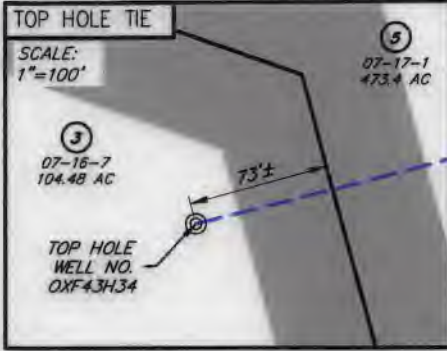

NO.	SURFACE OWNER
3	CATHY JEAN WETZEL, ET AL
5	RANDY E. & WILLIAM LEE HUFF
6	WILMA LEE LEESON
7	WM & RANDY HUFF DECEDEENTS
52	JAMES H. & JENNIE FOSTER
57	JANNETTE CONLEY
59	JANNETTE CONLEY
60	JANNETTE CONLEY
62	WILLIAM A. & SANDRA (MATHENY) ARMENTROUT
64	DONNA C. MATTHEWS

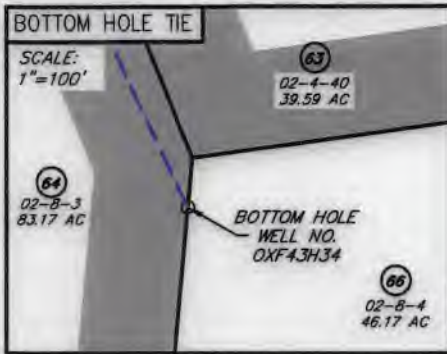

NO.	ADJACENT OWNER
58	TERRY E. LEESON
63	ROSS LEVINE
65	DAVID E. BOWYER
66	RONALD G. & VERONICA N. CLAYPOOL

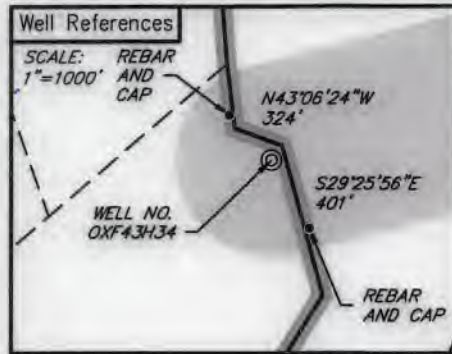

**LEGEND**

- ☆ EXISTING OIL/GAS WELL
- ⊙ WATER FEATURE
- ⊙ WELL HEAD TOP HOLE
- ▲ WELL LANDING POINT
- WELL BOTTOM HOLE
- REBAR FOUND
- DRILLED LATERAL LINE
- PERMITTED LATERAL LINE
- LEASE BOUNDARY
- PROPERTY LINE
- STREAM
- 500' LATERAL COLLECTION BUFFER



I, THE UNDERSIGNED, HEREBY CERTIFY THAT THIS PLAT IS CORRECT TO THE BEST OF MY KNOWLEDGE AND BELIEF AND SHOWS ALL THE INFORMATION REQUIRED BY LAW AND REGULATIONS ISSUED AND PRESCRIBED BY THE DEPARTMENT OF ENVIRONMENTAL PROTECTION.

*[Signature]*



FILE NO.: EES-60635  
DRAWING NO.: OXF43\_Well Plat  
SCALE: 1" = 2000'  
MINIMUM DEGREE OF ACCURACY: ±3'  
PROVEN SOURCE OF ELEVATION: GPS

**STATE OF WEST VIRGINIA**  
**DEPARTMENT OF ENVIRONMENTAL PROTECTION**  
**OFFICE OF OIL AND GAS**

DATE DECEMBER 15, 20 19  
OPERATORS  
WELL NO. OXF43H34  
API WELL NO. MWD  
47 017 06885  
STATE COUNTY PERMIT

WELL TYPE:  OIL  GAS  LIQUID INJECTION  WASTE DISPOSAL  (IF GAS) PRODUCTION:  STORAGE  DEEP  SHALLOW  
LOCATION, ELEVATION: 1229' (As-Built Pad) WATERSHED: Middle Fork Hughes River QUADRANGLE: OXFORD  
DISTRICT: SOUTH WEST / COVE COUNTY: DODDRIDGE  
SURFACE OWNER: Cathy Jean Wetzel, ET AL ACREAGE: 104.48± AC  
ROYALTY OWNER: Franklin Maxwell Heirs L. P. LEASE NO.: 107429 ACREAGE: 255± AC  
PROPOSED WORK:  DRILL  CONVERT  DRILL DEEPER  FRACTURE OR STIMULATE  PLUG OFF OLD FORMATION  
 PERFORATE NEW FORMATION  OTHER PHYSICAL CHANGE IN WELL (SPECIFY) \_\_\_\_\_  
 PLUG AND ABANDON  CLEAN OUT AND REPLUG TARGET FORMATION: MARCELLUS ESTIMATED DEPTH: 6,647'

WELL OPERATOR: EQT Production Company DESIGNATED AGENT: Joseph C. Mallow  
ADDRESS: 400 Woodcliff Drive ADDRESS: 115 Professional Pl. P.O. Box 280  
Canonsburg, PA 15317 Bridgeport, WV 26330

WWW.ENCOMPASSSERVICES.COM PLOT DATE: 12/15/2019 CAD FILE: OXF\_43\_WELL\_PLAT-2019-11-27.DWG

**INFORMATION SUPPLIED UNDER WEST VIRGINIA CODE  
Chapter 22, Article 6A, Section 5(a)(5)  
IN LIEU OF FILING LEASE(S) AND OTHER CONTINUING CONTRACT(S)**

Under the oath required to make the verification on page 1 of this Notice and Application, I depose and say that I am the person who signed the Notice and Application for the Applicant, and that –

(1) the tract of land is the same tract described in this Application, partly or wholly depicted in the accompanying plat, and described in the Construction and Reclamation Plan;

(2) the parties and recordation data (if recorded) for lease(s) or other continuing contract(s) by which the Applicant claims the right to extract, produce or market the oil or gas are as follows:

Lease Name or Number	Grantor, Lessor, etc.	Grantee, Lessee, etc.	Royalty	Book/Page
----------------------	-----------------------	-----------------------	---------	-----------

See Attached

**Acknowledgement of Possible Permitting/Approval  
In Addition to the Office of Oil and Gas**

The permit applicant for the proposed well work addressed in this application hereby acknowledges the possibility of the need for permits and/or approvals from local, state, or federal entities in addition to the DEP, Office of Oil and Gas, including but not limited to the following:

- WV Division of Water and Waste Management
- WV Division of Natural Resources WV Division of Highways
- U.S. Army Corps of Engineers
- U.S. Fish and Wildlife Service
- County Floodplain Coordinator

The applicant further acknowledges that any Office of Oil and Gas permit in no way overrides, replaces, or nullifies the need for other permits/approvals that may be necessary and further affirms that all needed permits/approvals should be acquired from the appropriate authority before the affected activity is initiated.

Well Operator: EQT Production Company  
 By: John Zavatchan  
 Its: Project Specialist -Permitting

RECEIVED  
Office of Oil and Gas

DEC 20 2019

Lease No.	Grantor, Lessor, etc.	Grantee, Lessee, etc.	Royalty	Book/Page
<b>107429</b>	<b>Franklin Maxwell Heirs L.P. (current royalty owner)</b>		**	
	W. Brent Maxwell, et al (original lessor)	Fisher Oil Co.		LB23/337
	Fisher Oil Co.	The Philadelphia Company of West Virginia		LB32/120
	The Philadelphia Company of West Virginia	Pittsburgh & West Virginia Gas Company		DB87/90
	Pittsburgh & West Virginia Gas Co.	Equitable Gas Company		DB121/303
	Equitable Gas Company	Equitrans, Inc.		LB154/475
	Equitrans, Inc.	Equitrans, L.P.		DB329/645
	Equitrans, L.P.	Equitable Production-Eastern States, Inc.		LB 192/19
	Equitable Production-Eastern States, Inc.	Equitable Production Company		CB281/346
	Equitable Production Company	EQT Production Company		CB281/346
<b>109481</b>	<b>Adele McDougal et al (current royalty owner)</b>		**	
	Jackson Leeson, et al (original lessor)	The Philadelphia Co. of West Virginia		LB21/76
	The Philadelphia Co. of West Virginia	Pittsburgh & West Virginia Gas Co.		DB87/90
	Pittsburgh & West Virginia Gas Co.	Equitable Gas Company		DB121/303
	Equitable Gas Company	Equitrans, Inc.		LB154/475
	Equitrans, Inc.	Equitrans, L.P.		DB329/645
	Equitrans, L.P.	Equitable Production-Eastern States, Inc.		LB 192/19
	Equitable Production-Eastern States, Inc.	Equitable Production Company		CB281/346
	Equitable Production Company	EQT Production Company		CB281/346
<b>1040986</b>	<b>Master Mineral Holdings II, L.P., et al (current royalty owner)</b>		**	
	Master Mineral Holdings II, L.P.	EQT Production Company		LB 488/594
<b>107437</b>	<b>Mansfield Leeson, et al (current royalty owner)</b>		**	
	F. L. Lodge (original lessor)	Fisher Oil Co.		LB22/277
	Fisher Oil Co.	The Philadelphia Oil Co.		LB24/64
	The Philadelphia Oil Co.	Pittsburgh and West Virginia Gas Company		DB87/90
	Pittsburgh and West Virginia Gas Company	Equitable Gas Co.		DB121/303
	Equitable Gas Co.	Equitrans, Inc.		LB154/475
	Equitrans, Inc.	Equitable Production-Eastern States, Inc.		LB192/19
	Equitable Production-Eastern States, Inc.	Equitable Production Company		CB281/346
	Equitable Production Company	EQT Production Co.		CB281/346
<b>116666</b>	<b>William Lee Huff, et al (current royalty owner)</b>		**	
	W. J. Hickman and Docie E. Hickman (original lessor)	Pittsburgh & West Virginia Gas Company		LB 35/429
	Pittsburgh and West Virginia Gas Company	Equitable Gas Company, a Pennsylvania corporation		DB 121/303
	Equitable Gas Company, a division of Equitable Resource	Equitrans, Inc.		LB 154/475
	Equitrans LP	Equitable Production-Eastern States Inc.		LB 155/160
	Equitable Production-Eastern States Inc.	Equitable Production Company		DB 281/346
	Equitable Production Company	EQT Production Company		DB 281/346
<b>1041534</b>	<b>Edward Van Scoy, et al (current royalty owner)</b>			
	Thurman Spurgeon and Nannie Spurgeon (original lessor)	Hope Natural Gas Company		LB 35/375
	Hope Natural Gas Company	Consolidated Gas Supply Corporation		DB 143/345
	Consolidated Gas Supply Corporation	Consolidated Gas Transmission Corporation		LB 135/583

RECEIVED  
 Office of Oil and Gas  
 DEC 20 2019  
 WV Department of Environmental Protection

	Condolitated Gas Transmission Corporation	CNG Development Company aka CNG Producing Company	LB 139/41
	CNG Producing Company	Dominion Exploration & Production Inc.	INC 234/1203
	Dominion Exploration & Production Inc.	Dominion Transmission, Inc.	LB 244/528
	Dominion Transmission, Inc.	CONSOL Energy Holdings LLC XVI	LB 245/1
	CONSOL Energy Holdings LLC XVII/CONSOL Gas Comp	CNX Gas Company LLC	DB 292/469
	CNX Gas Company LLC	Noble Energy, Inc.	LB 260/39
	CNX Gas Company LLC & Noble Energy, Inc.	Antero Resources Corporation	LB 400/565
	Antero Resources Corporation	EQT Production Company	LB 486/476
<b><u>1041532</u></b>	<b><u>Terry E. Leeson, et al (current royalty owner)</u></b>		**
	Joshua Adams and Satah E. Adams (original lessor)	J. W. Stuck	LB 28/172
	J. W. Stuck	Hope Natural Gas Company	LB 26/186
	Hope Natural Gas Company	Consolidated Gas Supply Corporation	DB 143/345
	Consolidated Gas Supply Corporation et al.	Consolidated Gas Transmission Corporation	LB 135/583
	Consolidated Gas Transmission Corporation	CNG Transmission Corporation	DB 332/563
	CNG Transmission Corporation	Dominion Transmission, Inc.	DB 332/570
	Dominion Transmission, Inc.	CONSOL Energy Holidngs LLC XVI	LB 245/1
	CONSOL Energy Holidngs LLC XVII/CONSOL Gas Co.	CNX Gas Company LLC	DB 292/469
	CNX Gas Company LLC	Noble Energy Inc.	LB 260/39
	CNX Gas Company and Noble Energy, Inc.	Antero Resource Corporation	LB 400/565
	Antero Resources Corporation	EQT Production Company	LB 486/476
<b><u>987367</u></b>	<b><u>Adam Minerals LLC, et al. (Current Royalty Owner)</u></b>		**
	Alice M. Brummage	EQT Production Company	LB 253/603
<b><u>988619</u></b>	<b><u>Driscoll K. Bell, et al (current royalty owner)</u></b>		**
	Driscoll K. Bell	EQT Production Company	LB 264/140
<b><u>998618</u></b>	<b><u>Sandra Renee Ebner, et al (current royaty owner)</u></b>		**
	Sandra Renee Ebner	EQT Production Company	LB 270/380
<b><u>987364</u></b>	<b><u>Richard Mullins, et al (current royalty owner)</u></b>		**
	Richard Mullins	EQT Production Company	LB 411/592
<b><u>987445</u></b>	<b><u>Trendon Spurgeon, et al (current royalty owners)</u></b>		**
	Trendon Spurgeon	Antero Resources Corporation	LB 417/91
	Antero Resources Corporation	EQT Production Copmpany	LB 486/476
<b><u>980873</u></b>	<b><u>R. Michael Ruppert, et al (current royalty owner)</u></b>		**
	R. Michael Ruppert	EQT Production Company	LB 278/113

\*\* Per West Virginia Code Section 22-6-8.

RECEIVED  
Office of Oil and Gas  
DEC 20 2019  
WV Department of  
Environmental Protection



EQT Production Company  
400 Woodcliff Drive  
Canonsburg, PA 15317  
www.eqt.com

John Zavatchan  
Landman - Permitting  
O:724-746-9073  
[jzavatchan@eqt.com](mailto:jzavatchan@eqt.com)

December 11, 2019

Mr. Taylor Brewer  
West Virginia Department of Environmental Protection  
Office of Oil and Gas  
601 57th Street SE  
Charleston, WV 25304

Re: OXF43H34 Gas Well  
Southwest District, Doddridge County

Dear Mr. Brewer,

EQT Production Company is applying for a modification to a well work permit for the well referenced above. Upon information and belief, the Operator's lease and/ or other real property rights permit it to conduct drilling operations for the subject well in the location shown on the plat, including under any public roads that the well lateral crosses.

Sincerely,

A handwritten signature in blue ink, appearing to read 'J. Zavatchan', is written over a light yellow rectangular background.

John Zavatchan  
Landman - Permitting

RECEIVED  
Office of Oil and Gas  
DEC 20 2019  
WV Department of  
Environmental Protection



WEST VIRGINIA DEPARTMENT OF TRANSPORTATION

Division of Highways

1900 Kanawha Boulevard East • Building Five • Room 110  
Charleston, West Virginia 25305-0430 • (304) 558-3505

Byrd E. White, III  
Secretary of Transportation/  
Commissioner of Highways

November 7, 2019

Jimmy Wriston, P. E.  
Deputy Secretary/  
Deputy Commissioner

James A. Martin, Chief  
Office of Oil and Gas  
Department of Environmental Protection  
601 57<sup>th</sup> Street, SE  
Charleston, WV 25304

Subject: DOH Permit for the OXF43 Well Site, Doddridge County

OXF43H20	OXF43H21	OXF43H22	OXF43H23	OXF43H24
OXF43H25	OXF43H26	OXF43H27	OXF43H28	OXF43H29
OXF43H30	OXF43H31	OXF43H32	OXF43H33	OXF43H34
OXF43H35	OXF43H36	OXF43H37		

Dear Mr. Martin,

This well site will be accessed from Permit # 04-2015-0394 has been issued to EQT Production Company for access to the State Road for a well pad located off County Rt. 23/3 SLS in Doddridge County.

This operator is in compliance with §22-6A-20 of the WV Code. Operator has signed a STATEWIDE OIL AND GAS ROAD MAINTENANCE BONDING AGREEMENT and provided the required Bond. This operator is currently in compliance with the DOH OIL AND GAS POLICY dated October 1, 2018.

Very Truly Yours,

Gary K. Clayton, P.E.  
Regional Maintenance Engineer  
Central Office O&G Coordinator

Cc: John Zavatchan  
EQT Production Company  
CH, OM, D-4  
File

RECEIVED  
Office of Oil and Gas  
L E F 3 0 2019  
WV Department of  
Environmental Protection

**PROJECT INFORMATION**

PROJECT NAME: B452 OXF 43 ASBUILT

**SURFACE OWNERS:**

RANDY E HUFF DECEDENTS TRUST B, ET AL  
LOT 4  
APN 7-17-1  
D B 247 PG 286

WETZEL, CATHY JEAN, ET AL  
APN 07-16-7  
D B 277 PG 105

GREATHOUSE, CHARLES R & EVELYN G  
APN 07-12-06  
D B 322 PG 340

MORRIS, I L  
APN 07-10-2  
D B 230 PG 307

COPELAND, MATHEW H  
APN 07-10-1  
D B 357 PG 5

**OIL AND GAS ROYALTY OWNER:**

FRANKLIN MAXWELL HEIRS LP  
DISTRICT(S): SOUTHWEST / COVE  
DODDRIDGE COUNTY, WV  
TOTAL PROPERTY AREA: 295± ACRES

**LOCATION COORDINATES**

OXF-43 SITE ENTRANCE  
LATITUDE: 39.100202 LONGITUDE: -80.797044 (NAD 83)  
NORTHING: 4,336,793.7 EASTING: 517,529.7 (UTM NAD 83 METERS)

OXF-43 CENTER OF WELL PAD  
LATITUDE: 39.157175 LONGITUDE: -80.792578 (NAD 83)  
NORTHING: 4,334,239.2 EASTING: 517,921.4 (UTM NAD 83 METERS)

**SITE DISTURBANCE COMPUTATIONS**

MAIN ACCESS ROAD = 39.93± ACRES  
WELL PAD AND ACCESS ROAD = 11.16± ACRES  
AST PAD A AND ACCESS ROAD = 6.37± ACRES  
AST PAD B AND WELL RELOCATION ROAD = 9.00± ACRES

**GENERAL DESCRIPTION**

THE OXF 43 PAD AND AST PADS ARE BEING CONSTRUCTED TO AID IN THE DEVELOPMENT OF INDIVIDUAL MARCELLUS SHALE GAS WELLS

**TITLE OF DRAWINGS**

- 01 SHEET
- 02 SHEET
- 03 ACCESS ROAD
- 03 ACCESS ROAD
- 03 ACCESS ROAD
- 03 ACCESS ROAD
- 03 ACCESS ROAD
- 03 ACCESS ROAD
- 03 ACCESS ROAD, WELL PAD AND ACCESS ROAD AND 10' A' AND ACCESS ROAD,
- 04 WELL PAD AND ACCESS ROAD, PAD 'A' AND ACCESS ROAD AND PAD 'B' AND WELL RELOCATION ROAD
- 04 PAD 'B' AND WELL RELOCATION ROAD
- 05 ROAD PROFILE
- 06 ROAD PROFILE
- 07 ROAD PROFILE
- 08 ROAD PROFILE AND PAD ACCESS ROAD PROFILE
- 09 ACCESS ROAD PROFILE AND WELL RELOCATION ROAD PROFILE

*Handwritten signature and date: JLD CN 12/16/19*

REVISION	DATE	DESCRIPTION	BY
1	04/23/18	AS BUILT UPDATE	KLH
2	12/03/19	ADDITION OF AST, UPDATE APN NUMBERS AND PAD DETAIL	KLH



Parcel #	LOD (Acres)	Wooded Area (Acres)
7-17-1	23.56	21.3
7-16-7	8.12	7.8
7-10-2	41.66	34.7
7-10-1	4.33	3.7
	77.07	67.5

	LOD (Acres)	Wooded Area (Acres)
7	45.99	38.4
	5.05	4.8
19, 18+89 to 24+27	3.32	2.9
	8.34	7.7
	3.27	3.2
	4.47	3.5
	7.23	7.0
	77.67	67.5

**LEGEND**

- LINES
- DISTURBANCE
- EDGE OF GRAVEL/DIRT
- CENTERLINE
- JNE
- RT
- E
- RINT
- GRAVEL PAD
- BERM
- CONSTRUCTION FENCE
- 1ST FILTER SOCK
- 2ND FILTER SOCK
- 3RD FILTER SOCK
- CONSTRUCTION ENTRANCE
- GROUND 2' CONTOURS
- 2' CONTOURS
- WELL LOCATIONS
- WELL LOCATIONS
- WELL LOCATIONS
- LINE
- NE MARKER
- HEAD UTILITY
- POLE
- TRE
- E

RECEIVED  
Office of Oil and Gas  
DEC 20 2019  
WV Department of Environmental Protection

**SURVEY NOTE**

1. THE CERTIFICATION OF THIS DRAWING APPLIES ONLY TO THE TOPOGRAPHIC MAPPING AS GENERATED FROM THE FIELD DATA OBTAINED AT THE TIME OF THE FIELD SURVEY ON 11-17-15, 11-25-15, 12-12-15, 12-14-15, 12-15-15, 12-20-15, 01-11-16, 02-05-16, 02-11-16, 02-26-15, 02-10-17, 07-05-17, 07-06-17, 07-18-17, 08-01-17, 08-08-17, AND 03-09-18.

MISS Utility of West Virginia  
1-800-245-4848  
West Virginia State Law  
(Section XIV: Chapter 24-C)  
Requires that you call two business days before you dig in the state of West Virginia  
**IT'S THE LAW!!**

THIS DOCUMENT WAS PREPARED BY:  
SLS LAND & ENERGY DEVELOPMENT  
FOR: EQOT



**OXF43 AS-BUILT SITE PLAN**  
THIS DOCUMENT WAS PREPARED BY:  
SLS LAND & ENERGY DEVELOPMENT  
FOR: EQOT PRODUCTION COMPANY

DATE: 10/03/2017  
EQOT  
SCALE: 1" = 1000'  
DESIGNED BY: T.W.  
FILE NO. 8452  
SHEET: 1 OF 18  
SLS  
B452 OXF 43 AS-BUILT Site Plan 04-18-18.dwg



# OXF43 AS-BUILT EQT PRODUCTION

## PROJECT INFORMATION

PROJECT NAME: B452 OXF 43 ASBUILT

## SURFACE OWNERS:

RANDY E. HUFF DECEDENT'S TRUST B, ET AL  
LOT 4  
APN 7-17-1  
D.B. 247 PG. 298

WETZEL, CATHY JEAN, ET AL  
APN 07-16-7  
D.B. 217 PG. 165

GREATHOUSE, CHARLES R. & EVELYN G.  
APN 07-13-65  
D.B. 322 PG. 340

MORRIS, I. L.  
APN 07-10-2  
D.B. 230 PG. 307

COPELAND, MATHEW H.  
APN 07-10-1  
D.B. 357 PG. 5

PERMITTED WELLS: API# 47-017-06739, 47-017-06743, 47-017-06744, 47-017-06745, 47-017-06884, 47-017-06885, 47-017-06888  
PROPOSED WELL NUMBER

SITUATE ON WATERS OF MIDDLE FORK OF THE  
SOUTHWEST DISTRICT, DODDRIDGE COUNTY  
LOCATION

## OIL AND GAS ROYALTY OWNER:

FRANKLIN MAXWELL HEIRS L.P.  
DISTRICT(S): SOUTHWEST / COVE  
DODDRIDGE COUNTY, WV  
TOTAL PROPERTY AREA: 255± ACRES

## LOCATION COORDINATES

OXF-43 SITE ENTRANCE  
LATITUDE: 39 180202 LONGITUDE: -80 797044 (NAD 83)  
NORTHING: 4,336,793.7 EASTING: 517,529.7 (UTM NAD 83 METERS)

OXF-43 CENTER OF WELL PAD  
LATITUDE: 39 157175 LONGITUDE: -80 792578 (NAD 83)  
NORTHING: 4,334,239.2 EASTING: 517,921.4 (UTM NAD 83 METERS)

## SITE DISTURBANCE COMPUTATIONS

MAIN ACCESS ROAD = 39.90± ACRES  
WELL PAD AND ACCESS ROAD = 11.10± ACRES  
AST PAD A AND ACCESS ROAD = 5.37± ACRES  
AST PAD B AND WELL RELOCATION ROAD = 9.00± ACRES

## GENERAL DESCRIPTION

THE OXF 43 PAD AND AST PADS ARE BEING CONSTRUCTED TO AID IN THE DEVELOPMENT OF INDIVIDUAL MARCELLUS SHALE GAS WELLS

RECEIVED  
Office of Oil and Gas

DEC 30 2019

WV Department of  
Environmental Protection

### SURVEY NOTE

1. THE CERTIFICATION OF THIS DRAWING APPLIES ONLY TO THE TOPOGRAPHIC MAPPING AS GENERATED FROM THE FIELD DATA OBTAINED AT THE TIME OF THE FIELD SURVEY ON 11-17-15, 11-25-15, 12-12-15, 12-14-15, 12-15-15, 12-20-15, 01-11-16, 02-05-16, 02-11-16, 02-26-16, 02-10-17, 07-05-17, 07-06-17, 07-18-17, 08-01-17, 08-08-17, AND 03-09-18.

MISS Utility of West Virginia  
1-800-245-4848  
West Virginia State Law  
(Section XIV: Chapter 24-C)  
Requires that you call two business days before you dig in the state of West Virginia.  
IT'S THE LAW!!

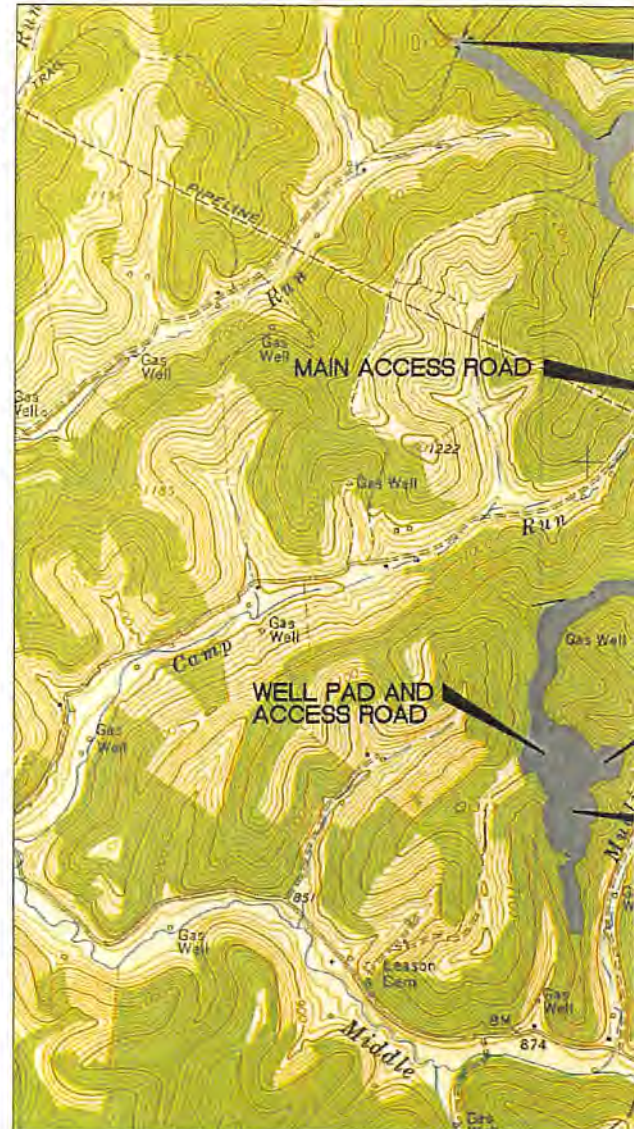

0 1000' 2000'  
SCALE: 1" = 1000'

# T SITE PLAN ON COMPANY

7-06740, 47-017-06741, 47-017-06742,  
17-06746, 47-017-06747, 47-017-06748,  
3, 47-017-06882, & 47-017-06883.  
ERS: OXF43H33

E SOUTH FORK OF HUGHES RIVER IN  
E COUNTY, WEST VIRGINIA  
I MAP

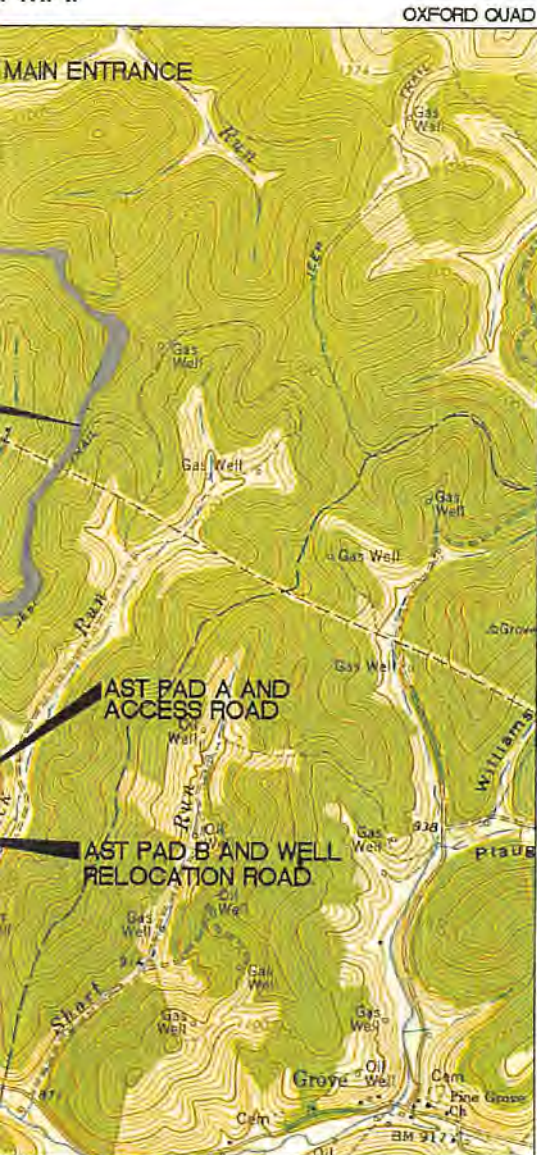

## LIST OF DRAWINGS

- 1 - COVER SHEET
- 2 - INDEX SHEET
- 3 - OXF-43 ACCESS ROAD
- 4 - OXF-43 ACCESS ROAD
- 5 - OXF-43 ACCESS ROAD
- 6 - OXF-43 ACCESS ROAD
- 7 - OXF-43 ACCESS ROAD
- 8 - OXF-43 ACCESS ROAD
- 9 - OXF-43 ACCESS ROAD, WELL PAD AND ACCESS ROAD AND PAD "A" AND ACCESS ROAD.
- 10 - OXF-43 WELL PAD AND ACCESS ROAD, PAD "A" AND ACCESS ROAD AND PAD "B" AND WELL RELOCATION ROAD
- 11 - OXF-43 PAD "B" AND WELL RELOCATION ROAD
- 12 - MAIN ROAD PROFILE
- 13 - MAIN ROAD PROFILE
- 14 - MAIN ROAD PROFILE
- 15 - MAIN ROAD PROFILE AND PAD ACCESS ROAD PROFILE
- 16 - PAD ACCESS ROAD PROFILE AND WELL RELOCATION ROAD PROFILE

*Handwritten signature and date: J. L. C. W. 12/16/19*

REVISION	DATE	DESCRIPTION	BY
1	04/23/18	AS BUILT UPDATE	KUH
2	12/03/19	ADDITION OF ASTA, UPDATE AP# NUMBERS AND PAD DETAIL	KLH



### LOD by property owner

Property Owner	Parcel #	LOD (Acres)	Wooded Area (Acres)
Randy E. Huff Decedent's Trust B (owns half)	7-17-1	23.56	21.3
William Lee Huff (owns half)			
Wetzel, Cathy Jean, ET AL	7-18-7	8.12	7.8
Moms, LL	7-19-2	41.66	34.7
Copeland, Mathew H	7-10-1	4.33	3.7
<b>Total Area</b>		<b>77.67</b>	<b>67.5</b>

### LOD by project area

Description	LOD (Acres)	Wooded Area (Acres)
Main Access Road, Sta. 0+00 to 134+44.27	45.99	38.4
Pit Access Road Sta. 0+00 to 18+00	5.05	4.8
Existing Well Road Relocation 0+00 to 4+99, 18+89 to 24+27	3.32	2.9
Well Pad	8.34	7.7
Tank Pad A	3.27	3.2
Tank Pad B	4.47	3.5
Waste and Spill	7.23	7.0
<b>Total Area</b>	<b>77.67</b>	<b>67.5</b>



THIS DOCUMENT WAS PREPARED BY: SLS LAND & ENERGY DEVELOPMENT FOR: EQT



**OXF43 AS-BUILT SITE PLAN**  
THIS DOCUMENT WAS PREPARED BY: SLS LAND & ENERGY DEVELOPMENT FOR: EQT PRODUCTION COMPANY

DATE: 10/03/2017  
EQT  
SCALE: 1" = 1000'  
DESIGNED BY: T.W.  
FILE NO. 8452  
SHEET: 1 OF 16

## LEGEND

PROPERTY LINES	---
LIMITS OF DISTURBANCE	---
EX. ROAD EDGE OF GRAVEL/DIRT	---
EX. ROAD CENTERLINE	---
EX. DITCHLINE	---
EX. CULVERT	---
EX. GASLINE	---
RIG FOOTPRINT	---
EDGE OF GRAVEL PAD	---
EDGE OF BERM	---
ORANGE CONSTRUCTION FENCE	---
12" COMPOST FILTER SOCK	---
18" COMPOST FILTER SOCK	---
24" COMPOST FILTER SOCK	---
TOP BERM	---
GRAVEL	---
RIP RAP	---
ROCK CONSTRUCTION ENTRANCE	---
ORIGINAL GROUND 2' CONTOURS	---
AS BUILT 2' CONTOURS	---
AS-BUILT WELL LOCATIONS	---
PROPOSED WELL LOCATIONS	---
ADJACENT WELL LOCATIONS	---
MATCHLINE	---
EX. FENCELINE	---
EX. GATE	---
EX. STRUCTURE	---
EX. PIPELINE MARKER	---
EX. OVERHEAD UTILITY	---
EX. POWER POLE	---
EX. GUY WIRE	---
EX. GASLINE	---

0 3000'  
000'

GRID NORTH AND SURVEYED ELEVATIONS SHOWN HEREON WERE ESTABLISHED BY DGPS SURVEY GRADE.



# WELL ELEVATION DETAIL

H37 (47-017-06883)		H27 (47-017-06747)
H36 (47-017-06882)		H26 (47-017-06745)
H35 (47-017-06886)		H25 (47-017-06744)
H34 (47-017-06885)		H24 (47-017-06742)
OXF43H33		H23 (47-017-06743)
H32 (47-017-06884)		H22 (47-017-06741)
H31 (47-017-06748)		H21 (47-017-06740)
H30 (47-017-06746)		H20 (47-017-06739)

SCALE - 1"=20'



RECEIVED  
Office of Oil and Gas

DEC 20 2019

WY Department of  
Environmental Protection

NOTE:  
ALL DATA SHOWN WITHIN THE BERM OF THE PAD WAS PROVIDED BY EQT FROM OTHERS.

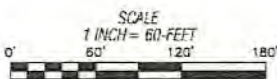

N/F  
CATHY JEAN WETZEL, ETAL  
APN: 07-16-7  
D.B. 277 PG. 165

N/F  
CATHY JEAN WETZEL, ETAL  
APN: 07-16-7  
D.B. 277 PG. 165



**OXF43 PAD AS-BUILT**  
 SITUATE ON WATERS OF MIDDLE FORK OF THE SOUTH FORK  
 OF HUGHES RIVER IN SOUTHWEST DISTRICT,  
 DODDRIDGE COUNTY, WEST VIRGINIA

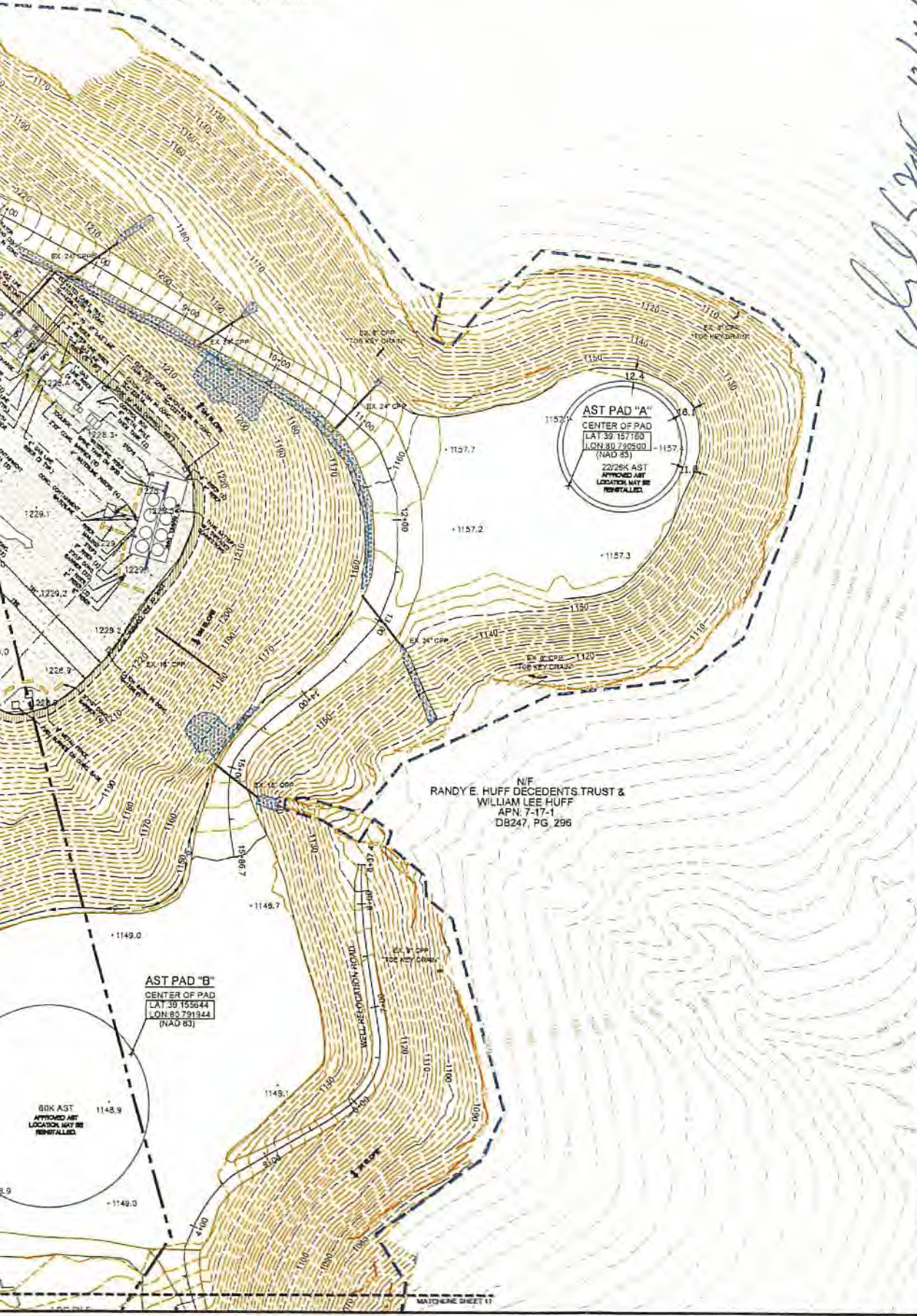

*John L. Huff* 12/16/19

REVISION	DATE	DESCRIPTION	BY
1	04/23/16	AS BUILT UPDATE	KLH
2	12/03/19	ADDITION OF AST'S, UPDATE APN NUMBERS AND PAD DETAIL	KLH
3	12/09/19	REPOSITIONED AST PER EOT	KLH



THIS DOCUMENT WAS PREPARED BY:  
 SLS LAND & ENERGY DEVELOPMENT  
 FOR: EOT

**OXF43  
 PAD AS-BUILT**

THIS DOCUMENT WAS PREPARED BY:  
 SLS LAND & ENERGY DEVELOPMENT  
 FOR: EOT PRODUCTION COMPANY

DATE: 04-05-2018  
 SCALE: 1"=80'  
 DESIGNED BY: T.W.  
 FILE NO. 8452  
 SHEET: 10 OF 16

ENC.  
 ONE OF 43 sheets of this plan 04-16-18.dwg