



west virginia department of environmental protection

Office of Oil and Gas
601 57th Street SE
Charleston, WV 25304
(304) 926-0450
(304) 926-0452 fax

Earl Ray Tomblin, Governor
Randy C. Huffman, Cabinet Secretary
www.dep.wv.gov

PERMIT MODIFICATION APPROVAL

November 05, 2015

NORTHEAST NATURAL ENERGY LLC
707 VIRGINIA STREET EAST
CHARLESTO, WV 25301

Re: Permit Modification Approval for API Number 6101691, Well #: BOGGESS 9H

Modify THL and add recycled water AST

Oil and Gas Operator:

The Office of Oil and Gas has reviewed the attached permit modification for the above referenced permit. The attached modification has been approved and well work may begin. Please be reminded that the oil and gas inspector is to be notified twenty-four (24) hours before permitted well work is commenced.

Please call James Martin at 304-926-0499, extension 1654 if you have any questions.

Sincerely,

Gene Smith *for Gene Smith*
Assistant Chief of Permitting
Office of Oil and Gas

Promoting a healthy environment.

11/06/2015

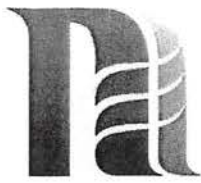

northeast
NATURAL ENERGY

July 10, 2015

WV Department of Environmental Protection
Office of Oil and Gas
601 57th Street SE
Charleston, WV 25304

Re: Boggess 5H and 9H Permit Modifications
API # 47-061-01690, 47-061-01691

Dear Permit Reviewer,

Northeast Natural Energy LLC ("NNE") would like to request modifications to its existing Boggess 5H and Boggess 9H Permits (061-01690, 061-01691). NNE has adjusted the top hole placement and horizontal well bores to allow for more efficient development of the permitted Boggess Well Pad. Additionally, NNE has adjusted the Boggess Well Pad design to accommodate an above ground storage tank for recycled water.

Please find enclosed with this request updated Mylar Plats, Well Bore Schematics, notice certificates, WW-6A-1 forms and attachments. Additionally revised WW-6B's, Site Safety Plans and a Well Pad Design with AST have been initialed by the inspector and are enclosed.

Should you have any questions please contact me at 304.241.5752 Ext. 7108 or by email at hmedley@nne-llc.com.

Sincerely,

Hollie M. Medley
Regulatory Coordinator

Received
Office of Oil & Gas
JUL 14 2015



west virginia department of environmental protection

Oil and Gas Conservation Commission
601 57th Street, SE Charleston, WV 25304
(304)926-0499, Ext 1656

Earl Ray Tomblin, Governor
Randy C. Huffman, Cabinet Secretary
dep.wv.gov

November 2, 2015

Department of Environmental Protection
Office of Oil and Gas
Charleston, WV 25304

RE: Application for Deep Well Permit – API #47-061-01691

COMPANY: Northeast Natural Resources, LLC

FARM: Blaek and Preston Boggess #9H

COUNTY Monongalia DISTRICT: Clay QUAD: Osage

The application for the above company is **approved to drill to Helderburg (with Marcellus completion).**

The applicant has complied with the provision of Chapter 22C-9, of the Code of West Virginia, nineteen hundred and thirty-one (1931), as amended, Oil and Gas Conservation Commission as follows:

1. Provided a certified copy of duly acknowledged and recorded consent and easement form from all surface owners; n/a
2. Provided a tabulation of all deep wells within one mile of the proposed location, including the API number of all deep wells, well name, and the name and address of the operator; none
3. Provided a plat showing that the proposed location is a distance of >400 feet from the nearest **lease line** or unit boundary and showing the following wells drilled to or capable of producing from the objective formation within 3,000 feet of the proposed location.

Sincerely,

Cindy Raines
Executive Assistant

STATE OF WEST VIRGINIA
DEPARTMENT OF ENVIRONMENTAL PROTECTION, OFFICE OF OIL AND GAS
WELL WORK PERMIT APPLICATION

1) Well Operator: Northeast Natural Energy LLC 494498281 Monongalia Clay Osage, WV
Operator ID County District Quadrangle

2) Operator's Well Number: Boggess 9H Well Pad Name: Boggess

3) Farm Name/Surface Owner: Blake R. & H. Preston Boggess Public Road Access: Mason Dixon Hwy (State Rt 7)

4) Elevation, current ground: 1296' Elevation, proposed post-construction: 1268'

5) Well Type (a) Gas Oil _____ Underground Storage _____

Other _____

(b) If Gas Shallow _____ Deep

Horizontal

6) Existing Pad: Yes or No No *MDK 6/17/2015*

7) Proposed Target Formation(s), Depth(s), Anticipated Thickness and Expected Pressure(s):
Pilot: Helderburg at 8,500' , Horizontal: Marcellus at 8,092', 103' , 3,600 psi

8) Proposed Total Vertical Depth: Pilot: 8,500' ; Horizontal: 8,092'

9) Formation at Total Vertical Depth: Pilot: Helderburg ; Horizontal: Marcellus

10) Proposed Total Measured Depth: 16,605'

11) Proposed Horizontal Leg Length: 7,036'

12) Approximate Fresh Water Strata Depths: 50' ; 1,209'

13) Method to Determine Fresh Water Depths: Driller's Log from Offset Wells

14) Approximate Saltwater Depths: 1,784' ; 2,435'

15) Approximate Coal Seam Depths: 934' ; 1,207'

16) Approximate Depth to Possible Void (coal mine, karst, other): _____

17) Does Proposed well location contain coal seams directly overlying or adjacent to an active mine? Yes _____ No

(a) If Yes, provide Mine Info: Name: _____

Depth: _____

Seam: _____

Owner: _____

Received
Office of Oil & Gas
JUL 14 2015

4706101691

WW-6B
(04/15)

API NO. 47- _____ - _____
 OPERATOR WELL NO. Boguess 9H
 Well Pad Name: Boguess

18)

CASING AND TUBING PROGRAM

TYPE	Size (in)	New or Used	Grade	Weight per ft. (lb/ft)	FOOTAGE: For Drilling (ft)	INTERVALS: Left in Well (ft)	CEMENT: Fill-up (Cu. Ft.)/CTS
Conductor	24"	New	NA	94.71	40'	40'	GTS
Fresh Water	13-3/8"	New	J-55	54.5	1,290'	1,260'	CTS
Coal							
Intermediate	9-5/8"	New	J-55	40	2,530'	2,500'	CTS
Production	5-1/2"	New	P-110	20	16,605'	16,575'	3,824 Cu. Ft.
Tubing	2-7/8"	New	N-80	6.5	NA	8,500'	NA
Liners							

Northeast Natural Energy LLC requests the ability to drill beyond elevation for the purpose of isolating the Red Rock Formation.

TYPE	Size (in)	Wellbore Diameter (in)	Wall Thickness (in)	Burst Pressure (psi)	Anticipated Max. Internal Pressure (psi)	Cement Type	Cement Yield (cu. ft./k)
Conductor	24"	30"	.375	415		4,500 pst Grout	NA
Fresh Water	13-3/8"	17 1/2"	.38"	2,760	2,000	Class A	1.23
Coal							
Intermediate	9-5/8"	12 1/4"	.395"	3,950	3,000	Class A	1.3
Production	5-1/2"	8 3/4"	.361"	12,530	9,700	50:50 Poz	1.21
Tubing	2-7/8"	NA	.217"	10,570	3,600	NA	NA
Liners							

PACKERS

GAS
11/5/15

Kind:				
Sizes:				RECEIVED Office of Oil and Gas
Depths Set:				NOV 5 2015

WV Department of
Environmental Protection

19) Describe proposed well work, including the drilling and plugging back of any pilot hole:

Drilling and completion of a horizontal Marcellus well. The well will be drilled on air to an approximate depth of 7,840' TVD/MD. A pilot hole will then be drilled on synthetic based mud to an approximate depth of 8,500' and plugged back with solid cement to the KOP at approximately 7,200' TVD. The well will then be horizontally drilled on synthetic based mud from the KOP to approximately 8,092' TVD / 16,605' MD along a 325 degree azimuth.

20) Describe fracturing/stimulating methods in detail, including anticipated max pressure and max rate:

Multi-stage / high-rate slickwater fracture treatment using various size sands as proppant. First stage will be initiated via pressurization against a burst disc ran in the production casing string or perforated with coiled tubing. Subsequent stages will be perforated with pumped down guns ran on wireline. Individual stages will be isolated with composite frac plugs. Maximum pump rate during any stage will be 110 BPM with a maximum allowable surface pressure of 9,500 PSI. Composite bridge plugs will be set at the end of the last stage to isolate the treated formation.

21) Total Area to be disturbed, including roads, stockpile area, pits, etc., (acres): 20.18

22) Area to be disturbed for well pad only, less access road (acres): 11.67

23) Describe centralizer placement for each casing string:

Surface and intermediate casing strings will have bow spring centralizers placed every third joint (~120') from the shoe joint to surface. Production casing will have rigid body centralizers placed at a minimum of every fourth joint (~160') from TD to surface.

24) Describe all cement additives associated with each cement type:

Surface string cement will be a Class A + Max 3% bwoc Calcium Chloride Fresh Water blend. Intermediate string cement will be a Class A Cement + Max 3% bwoc Calcium Chloride + Fresh Water. Production string cement will be (50:50) Poz (Fly Ash):Type I Cement with a gas migration additive.

25) Proposed borehole conditioning procedures:

Surface string will use a 25.0 bbls Gel Pill + LCM + 25 lbs Cello Flake + 20 lbs/bbl Bentonite @ 8.4 ppg & 10 bbls fresh water spacer prior to cement. Intermediate string will use a 25.0 bbls Gel Pill + LCM + 25 lbs Cello Flake + 20 lbs/bbl Bentonite @ 8.4 ppg & 10 bbls fresh water spacer prior to cement. Production string will use a 50.0 bbls SealBond 25 + 1 gal/bbl US-40 + 20 lbs/bbl Barite + 1 gal/bbl SS-2 Spacer @ 13.5 ppg prior to cement.

*Note: Attach additional sheets as needed.

received
Office of Oil & Gas
JUL 14 2015

Job Number:
 Company: Northeast Natural Energy
 Lease/Well: Boggess 9H
 Location: Boggess
 Rig Name: Pioneer 63
 State/Country: WV/ Mon
 Country: US
 API Number:



Elevation (To MSL): 1268.00 ft
 RKB: 18.00 ft
 Projection System: US State Plane 1983
 Projection Group: West Virginia Northern Zone
 Projection Datum: GRS80
 Magnetic Declination: -8.96
 Grid Convergence: -0.37791 W
 Date: Monday, May 18, 2015

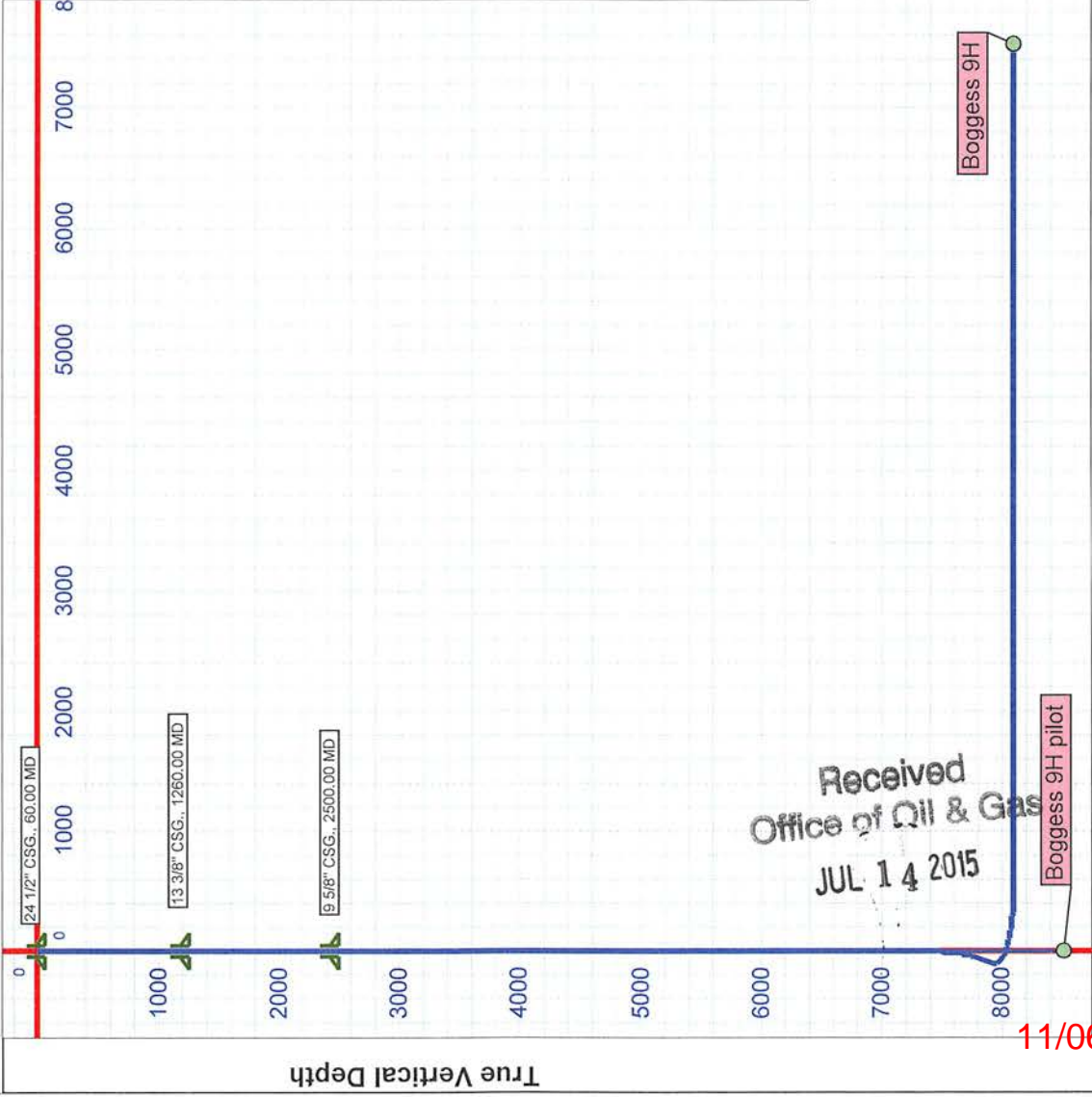
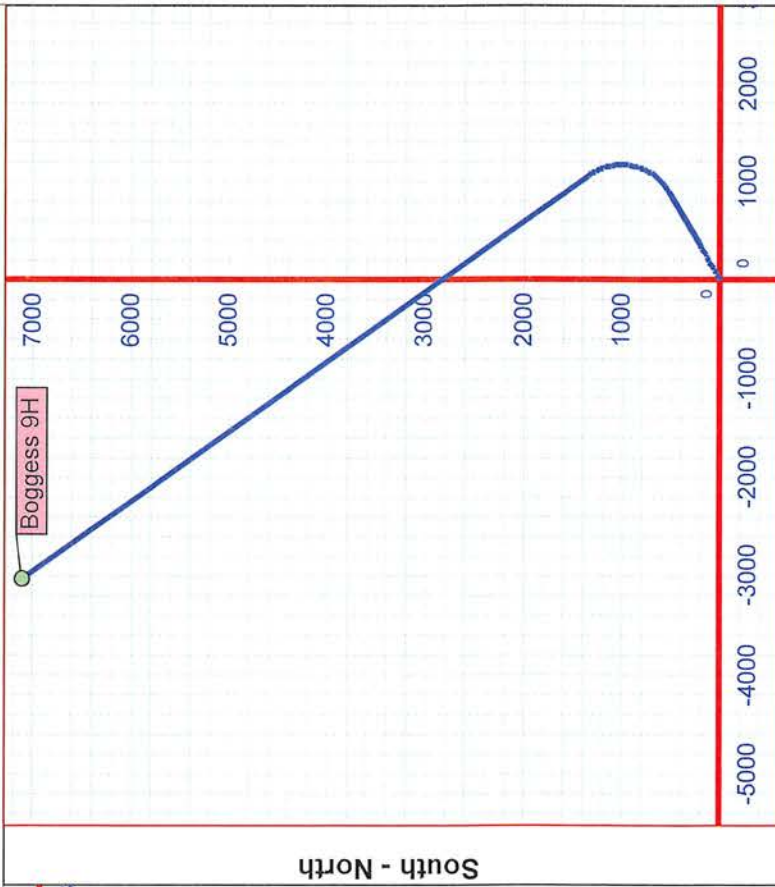

Received
 Office of Oil & Gas
 JUL 14 2015

4706101691

West - East

MD	TVD	West - East
KOP	7,200	Tully
LP	9,543	Hamilton
TD	16,605	Upper Marcellus
Pilot	8,500	Lower Marcellus
		Onondaga
		Oriskany
		Helderburg
		End Helderburg
		7,840
		7,904
		8,011
		8,056
		8,114
		8,139
		8,270
		8,500

Vertical Section (1000 Ft/Div) VSP: 324.00°

11/06/2015

4706101691



northeast

NATURAL ENERGY

Bogges 9H

SITE SAFETY PLAN

June 4, 2015

MDK
6/17/2015

Received
Office of Oil & Gas
JUL 14 2015

11/06/2015

SITE NAME Bogges 9H

COUNTY Monongalia

ACCESS ROAD ENTRANCE N39° 39' 59.23" , W-80° 05' 48.82 (NAD 83)

N 4391127.465, E 577463.266 (NAD 83 UTM)

DIRECTIONS TO SITE:

From I-79, take exit 155. Merge onto Chaplin Hill Road/CR-19/24N toward US-19/WV-7/Star City. If traveling from the south, this will be a right off the exit. If traveling from the north, this will be a left off the exit. After approximately 0.8 miles, turn left at light onto US-19/WV-7. Continue on US-19/WV-7 for approximately 1.7 miles. Turn left on WV-7 and continue on route for approximately 4.0 miles. The Bogges Pad Access Road Entrance will be on the right.

From Blacksville, take WV-7 E/Mason Dixon Highway for approximately 10.1 miles. The Bogges Pad Access Road Entrance will be on the left.

*See Attached Maps

Received
Office of Oil & Gas
JUL 14 2015

11/06/2015

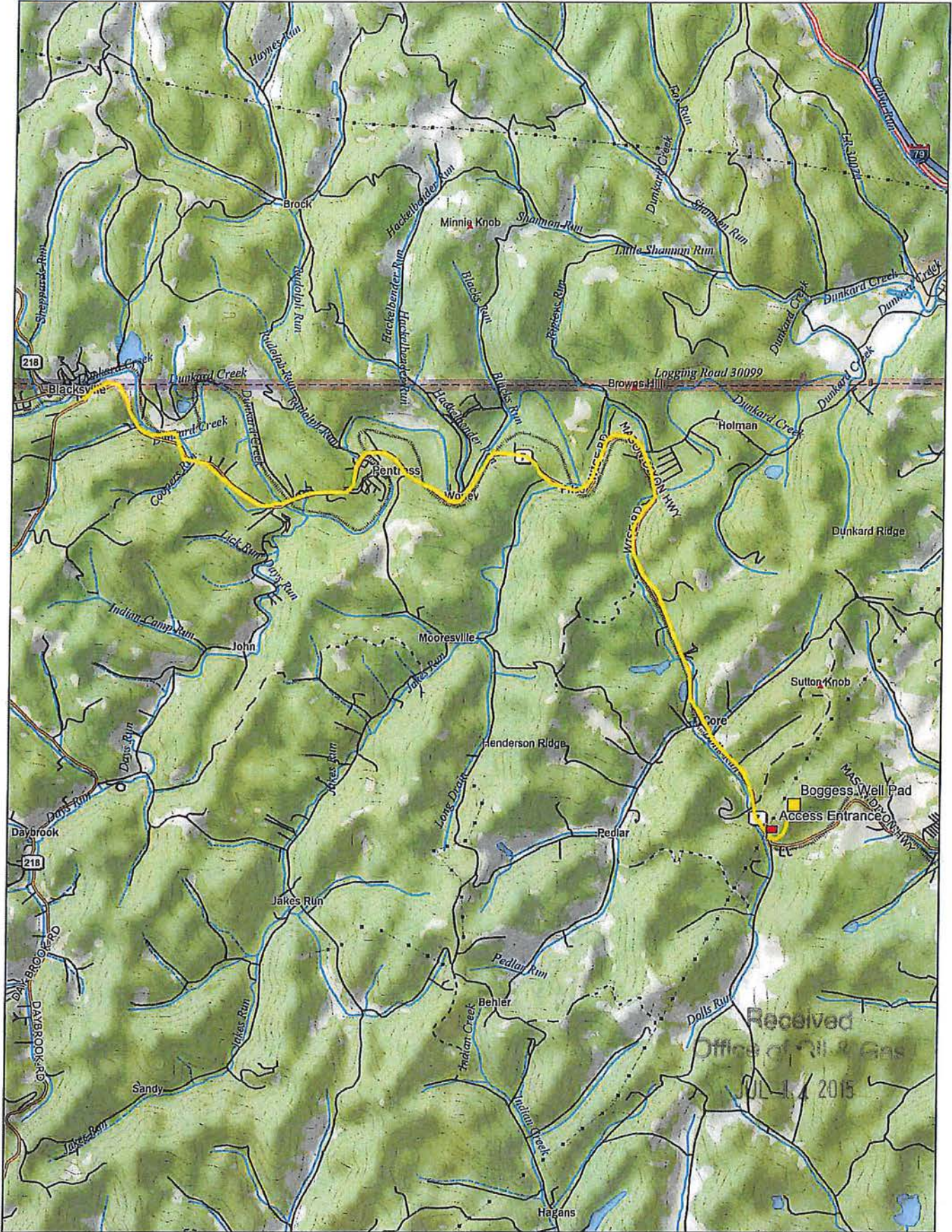

Data use subject to license.
 © DeLorme. XMap® 7.
 www.delorme.com

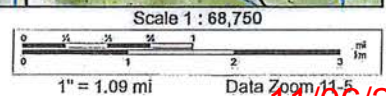

11/06/2015

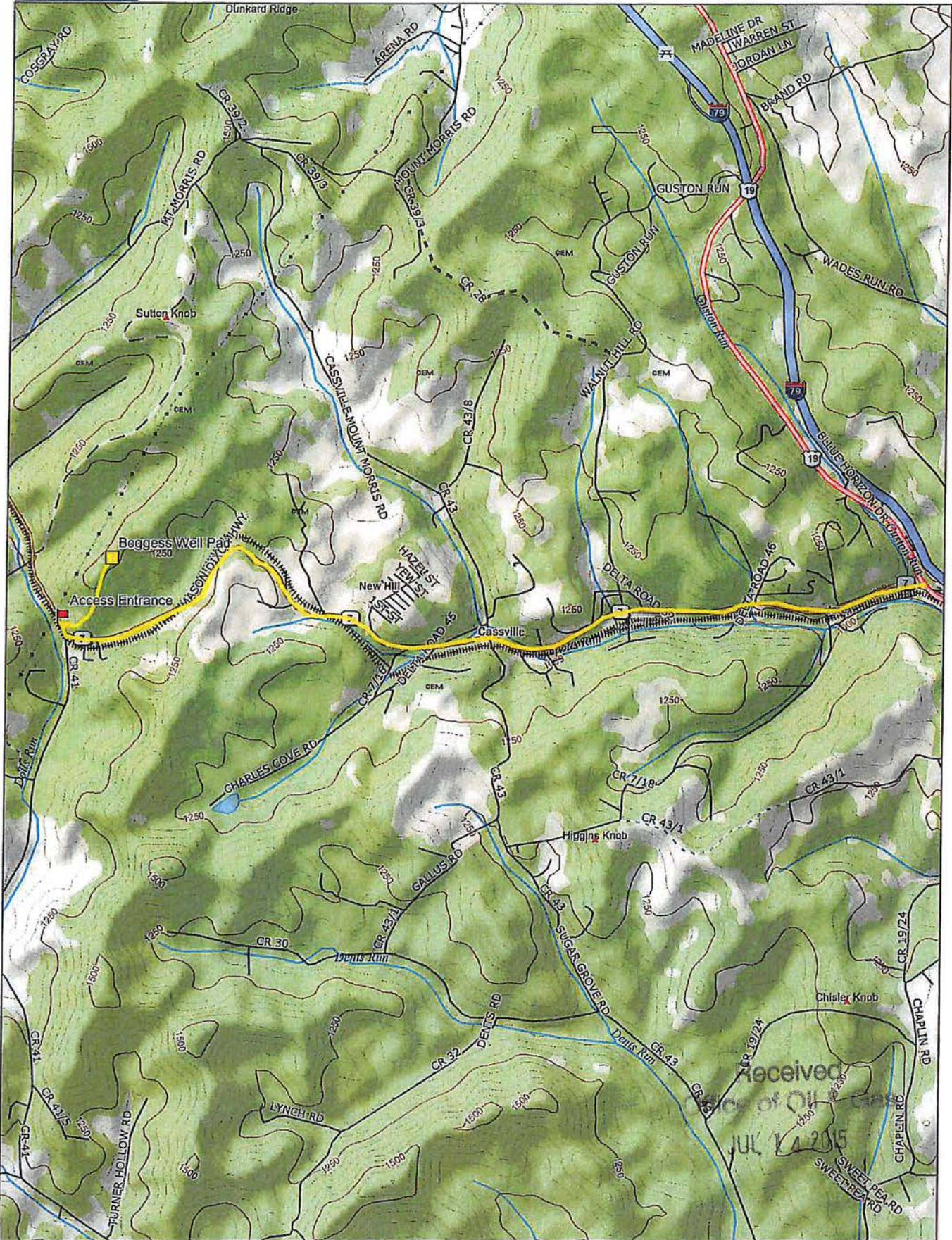

Data use subject to license.

© DeLorme. XMap® 7.

www.delorme.com



Scale 1 : 34,375

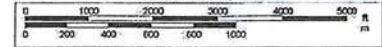

1" = 2,864.6 ft

Data Zoom 12.5

11/06/2015

Introduction

Northeast Natural Energy LLC (“NNE”) is an oil and gas exploration and production company with company headquarters located at the following address:

Northeast Natural Energy LLC
707 Virginia Street East, Suite 1200
Charleston, WV 25301

And a Field Operations Office located at the following address:

Northeast Natural Energy LLC
48 Donley Street, Suite 601
Morgantown, WV 26501

NNE is committed to protecting the people, property, and resources of the company and of the communities in which it works by establishing a safe and healthy work environment that is free from recognized hazards and complies with all local, state and federal regulations.

This Plan will be reviewed annually and may be subject to revision and/or update whenever any of the following occur:

- An incident occurs.
- A new chemical or process is utilized onsite.
- Existing processes are modified significantly.
- Regulations are revised significantly.
- The current Plan fails in an emergency situation.
- Changes in emergency response equipment occur.
- Changes in internal and external emergency resources occur.

Received
Office of Oil & Gas
JUL 14 2015

11/06/2015

TABLE OF CONTENTS

- 1 – Contacts, Schedules and Meetings**
- 2 – Maps and Diagrams**
- 3 – Well Work**
- 4 – Chemical Inventory & MSDS**
- 5 – BOP and Well Control**
- 6 – Hydrogen Sulfide (H₂S)**
- 7 – Flaring**
- 8 – Collision Avoidance Safeguards, Practices and Procedures**
- 9 – Deep Well Additional Requirements**

Received
Office of Oil & Gas
JUL 14 2015

11/06/2015

1

Contacts, Schedules and Meetings

Received
Office of Oil & Gas
Received
Office of Oil & Gas
JUL 14 2015
JUL 14 2015

11/06/2015

A. NORTHEAST NATURAL ENERGY LLC CONTACTS:

24 hour emergency number 1-866-207-1846

Construction/Reclamation

- Mike Shreve – Construction Coordinator 304.918.3050
- Dave McDougal – Manager of Civil Engineering 304.941.5033
- Brett Loflin – VP of Regulatory Affairs 304.414.7063

Drilling/Completion

- Jay Hewitt – Drilling Manager 304.382.1825
- Ian Costello – Completions Engineer 304.610.9764
- Zack Arnold – Manager of Operations 304.203.8059

Production

- Ryan Warner - Production Engineer 304.777.3287
- Zack Arnold – Manager of Operations 304.203.8059

B. EMERGENCY CONTACTS :

In the case of an emergency call 911

1. OPERATOR CONTACTS

- 24 hour emergency number 1-866-207-1846

2. DRILLING CONTRACTORS

- Performance Drilling –Vertical Drilling 304.553.2180
- Pioneer Drilling – Horizontal Drilling 570.465.2151

KEY CONTRACTORS AND VENDORS

- Baker Hughes – Cement/Pumping 724.743.9208
- Halliburton – Cement/Pumping 888.223.4255
- Schlumberger – Logging/Cement 724.820.3360

3. WV DEP/ OFFICE OF OIL AND GAS

Pollution and Emergency Spills 1-800-642-3074

- James Martin – Chief
- Gayne Knitoswski – Inspector
- Joe McCourt– WV DEP Northern Inspector Supervisor

Received
304.926.0800
Office of Oil & Gas
Office of Oil & Gas
304.526.0174
JUL 14 2015
JUL 14 2015
304.480.4405

11/06/2015

4. LOCAL EMERGENCY RESPONSE UNITS

MONONGALIA COUNTY OFFICE OF EMERGENCY MANAGEMENT

- Mike Wolfe – Director 304.598.0301
- James Smith – Deputy Director

FIRE DEPARTMENTS

- Blacksville Volunteer 304.432.8282

AMBULANCE / EMS

- MON EMS 304.599.0650
- JAN-CARE 304.296.9700

LIFE FLIGHT AMBULANCE SERVICE (HELICOPTER)

- Angel MedFlight 866.604.8307

STATE POLICE

- Morgantown Detachment 304.285.3200

COUNTY POLICE

- Monongalia Sheriff 304.291.7290

5. LOCAL ER PERSONNEL

HOSPITAL

- Ruby Memorial (trauma 1) 304.598.4000
- Monongalia General (trauma 4) 304.598.1200

Received
Office of Oil & Gas
Office of Oil & Gas
JUL 14 2015

11/06/2015

Structure	Type	Owner	Street Address	City/Zip	304-328-XXXX	District	Tax Map Parcel
1	Golf Course	Ayers and Ayers Holdings	PO Box 1310	Inwood, WV 25428	304-328-0111	Cass	11
2	Mining, Training Site	WVU Board of Governors	2870 Little Indian Creek Road	Morgantown, WV 26501	No listed phone number	Clay	15
3	Business	Poffenberger Family Trust: Charlene Frances Horan	1929 Mason Dixon Highway	Maidsville, WV 26541	304-879-5920	Clay	12
29,30	Residence/Private Structure	Billy Poffenberger: Poffenberger Family Revocable Living Trust	117 Forrest Drive	Morgantown, WV 26505	304-879-5868/304-999-9533	Clay	12
31,33	Residence/Private Structure	Billy Poffenberger: Poffenberger Family Revocable Living Trust	117 Forrest Drive	Morgantown, WV 26505	304-879-5868/304-999-9533	Clay	12
4,5	Residence/Private Structure	Roy Eddy	297 Stull Road	Maidsville, WV 26541	304-879-5868	Clay	13,14
6	Residence/Private Structure	Betty Wiley	373 Dunkard Avenue	Morgantown, WV 26501	304-879-5868	Clay	14
7	Residence/Private Structure	Chad Forman	1543 Mason Dixon Highway	Core, WV 26541	304-879-5868	Clay	15
8	Residence/Private Structure	Donald Masters	1557 Mason Dixon Highway	Maidsville, WV 26541	304-879-5868	Clay	12
9	Residence/Private Structure	Marilyn Corbin	1581 Mason Dixon Highway/P.O. Box 278	Maidsville, WV 26541	304-879-5868	Clay	15
10,11,13,26	Residence/Private Structure	Blake Bogess	1584 Mason Dixon Highway	Maidsville, WV 26541	No listed phone number	Clay	15
12	Residence/Private Structure	David Fox	1605 Mason Dixon Highway	Maidsville, WV 26541	304-879-5868	Clay	12
14	Residence/Private Structure	Brittany Swanson	1643 Mason Dixon Highway	Maidsville, WV 26541	No listed phone number	Clay	15
15,16,17	Residence/Private Structure	Donald & Nelle Marlene Tennant	37 Tennant Lane	Maidsville, WV 26541	304-883-8262	Clay	15
18	Residence/Private Structure	Thomas Hellyer	1681 Mason Dixon Highway	Maidsville, WV 26541	304-879-5775	Clay	15
19	Residence/Private Structure	Mary Jane Walls	3230 Mason Dixon Highway	Maidsville, WV 26541	304-879-5231	Clay	15
20	Residence/Private Structure	Donna Sue and David Jones	3106 Little Indian Creek Road	Core, WV 26541	304-883-2159	Clay	15
21	Residence/Private Structure	Tyler Elliot and Katherine Brewer	3120 Little Indian Creek Road	Maidsville, WV 26541	304-879-5477	Clay	15
22	Residence/Private Structure	Laurie Cozart	30 Tennant Lane	Core, WV 26541	No listed phone number	Clay	15
23	Residence/Private Structure	Dave and Donna Sue Jones	3106 Little Indian Creek Road	Maidsville, WV 26541	304-883-2159	Clay	15
24	Residence/Private Structure	Timothy Limg	3090 Little Indian Creek Road	Maidsville, WV 26541	304-879-5591	Clay	15
25	Residence/Private Structure	Danny & Deanna Tennant	345 Danny T Lane	Core, WV 26541	304-879-5199	Clay	15
27,28	Residence/Private Structure	Darlene Klubeck	537 Pedlar Run Road	Maidsville, WV 26541	No listed phone number	Clay	15
32	Residence/Private Structure	Danny & Deanna S. Tennant	345 Danny T Lane	Maidsville, WV 26541	304-879-5199	Clay	12

C. NOTIFICATION OF H₂S GAS PRESENCE

Detection of H₂S shall sound an alarm which notifies personnel to shut in the well(s) and evacuate to the predetermined safe zone immediately.

A wind sock and/or flags will be utilized on location to identify wind direction. A safe zone upwind and away from the well will be established at the beginning of each tour. Personnel are trained to evacuate the well and gather at this safe zone immediately at the first sound of an H₂S explosive gas alarm.

When in a historically known area, or after H₂S is first detected, operations will halt, evacuation procedures will be followed, and all personnel will be trained for detailed H₂S protocols before operations begin or resume.

After personnel are located in a safe area, the onsite supervisor will take a head count, and make the proper offsite notifications. The DEP Office of Oil and Gas will be notified by a phone call to both the local inspector and the emergency number. The local emergency responders may also be notified of the detection.

In the event that H₂S has been detected, the onsite supervisor shall use his discretion as to the severity of the event and whether the local community should be notified. NNE will make a diligent effort to identify local residents and businesses within a ½ mile radius of its unconventional well sites (*see attached). Notification of such residence may be done in the form of a phone call or a door to door visit. NNE also recognizes that in most emergency situations the local emergency responders will coordinate any notification or evacuation procedures for the community and NNE will work closely with such emergency responders in their efforts.

Received
Office of Oil & Gas
JUL 14 2015

11/06/2015

D. PRE-SPUD MEETINGS

Prior to drilling operations, an onsite "Pre-Spud" meeting will be held to address operations and the site safety plan. This meeting shall include the overseeing NNE Drilling/Completions Engineer, the staff or contracted site supervisor(s) ("Company Man"), any staff or contracted safety personnel, key contractors to the drilling process, the contracted rig's superintendent/tool pusher, and the local oil and gas inspector if available. Local emergency response personnel may also be invited to the pre-spud meeting. The regional DEP inspector will be notified 48-hours in advance of the meeting. All attending personnel will be documented. Contractors will be provided copy of and instructed to go over the site safety plan with their respective individual employees:

E. WELL SITE SAFETY MEETINGS

Safety Meetings will be held on-site, at a minimum, on a weekly basis and prior to the beginning of drilling, completion and work-over operations. Attendance at each safety meeting will be logged.

Additionally, as a means of safety and maintaining a head count in case of an incident, a check-in and check-out list of both personnel and visitors will be kept during all drilling, completion, and work over phases of operation. The rig/frac supervisor will be responsible for the checking in and out of all personnel on location. A sign will be posted at the entrance to the location directing all visitors to the company trailer.

2

Maps and Diagrams

Received
Office of Oil & Gas
JUL 14 2015

11/06/2015



Data use subject to license.
 © DeLorme, XMap® 7.
 www.delorme.com

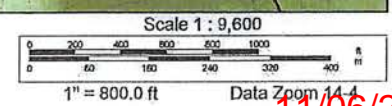
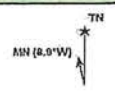

Received
 Office of Oil & Gas
 JUL 14 2015

11/06/2015

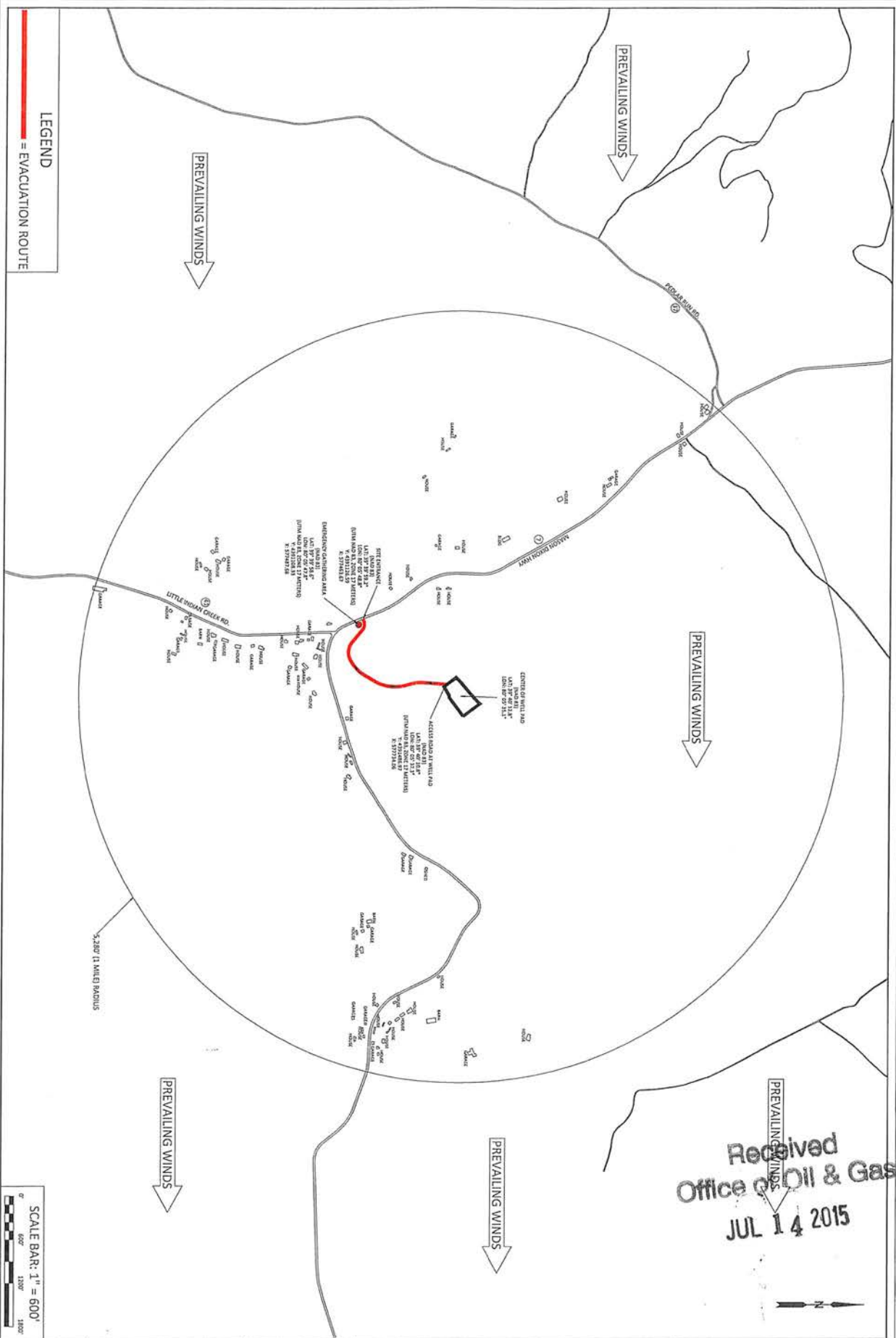

LEGEND
 = EVACUATION ROUTE

SCALE BAR: 1" = 600'
 0 600 1200 1800'

SHEET 1

Received
 Office of Oil & Gas
 JUL 14 2015



DATE	REVISIONS	DESCRIPTION

JUNE 2015
 BOGGESS
 WELL PAD
 CLAY DISTRICT
 MONONGALIA
 COUNTY, WV

**EVACUATION ROUTE/
 PREVAILING WINDS**
 THIS DOCUMENT WAS PREPARED BY:
 BOORD, BENCHEK AND ASSOC., INC.
 FOR: NORTHEAST NATURAL ENERGY LLC

BOORD, BENCHEK and ASSOC., INC.
 Engineering, Surveying, Construction,
 and Mining Services
 Southpointe, PA 15317 Phone: 724-746-1055

11/06/2015

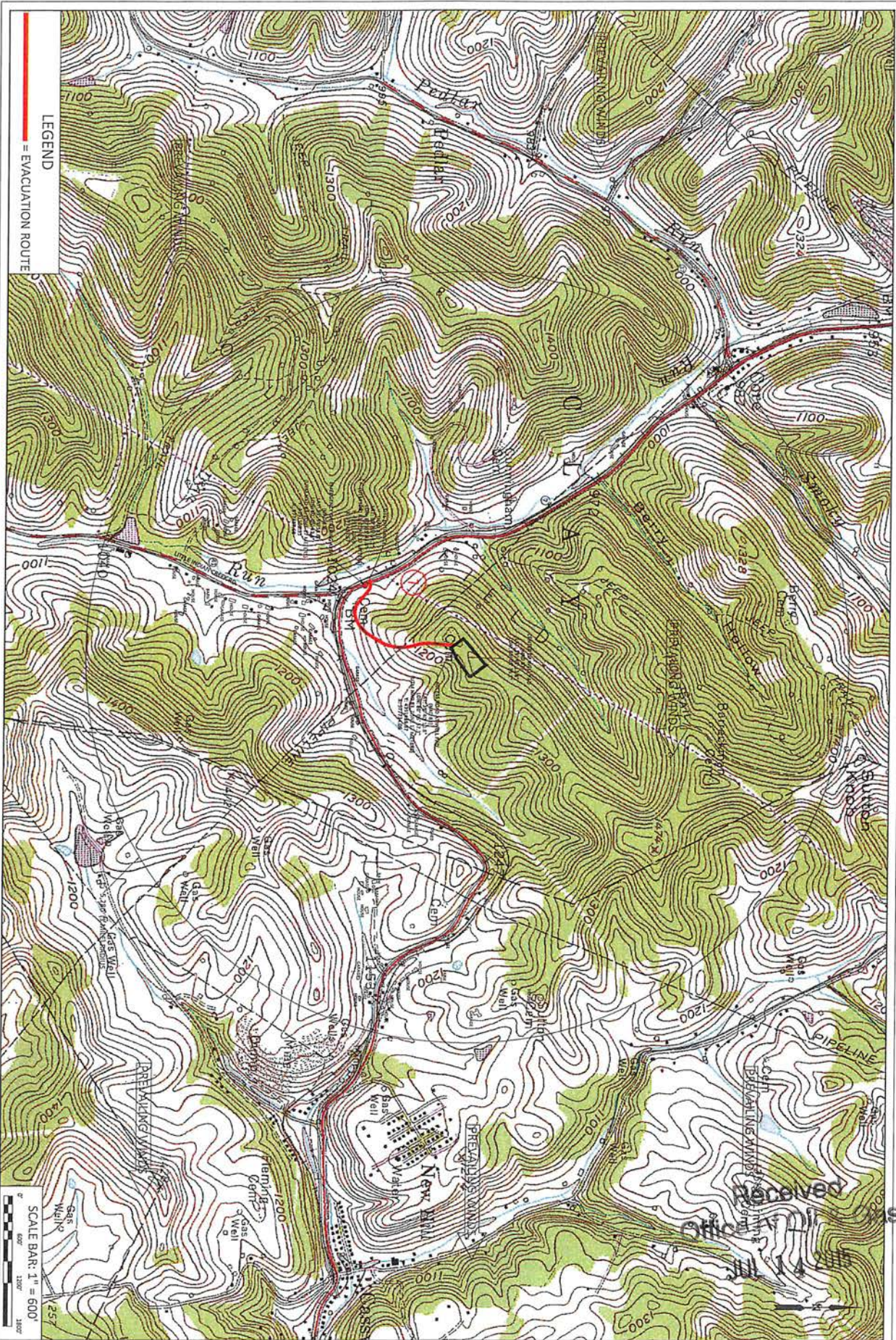

LEGEND

= EVACUATION ROUTE

SCALE BAR: 1" = 600'

SHEET 2



NO.	DATE	REVISIONS

JUNE 2015
BOARDS
WELL PAD
CLAY DISTRICT
MONONGALIA
COUNTY, WV

**EVACUATION ROUTE/
PREVAILING WINDS**

THIS DOCUMENT WAS PREPARED BY:
BOORD, BENCHEK AND ASSOC., INC.
FOR: NORTHEAST NATURAL ENERGY LLC

BOORD, BENCHEK and ASSOC., INC.
Engineering, Surveying, Construction,
and Mining Services

Southpointe, PA 15317 Phone: 724-746-1151

11/06/2015

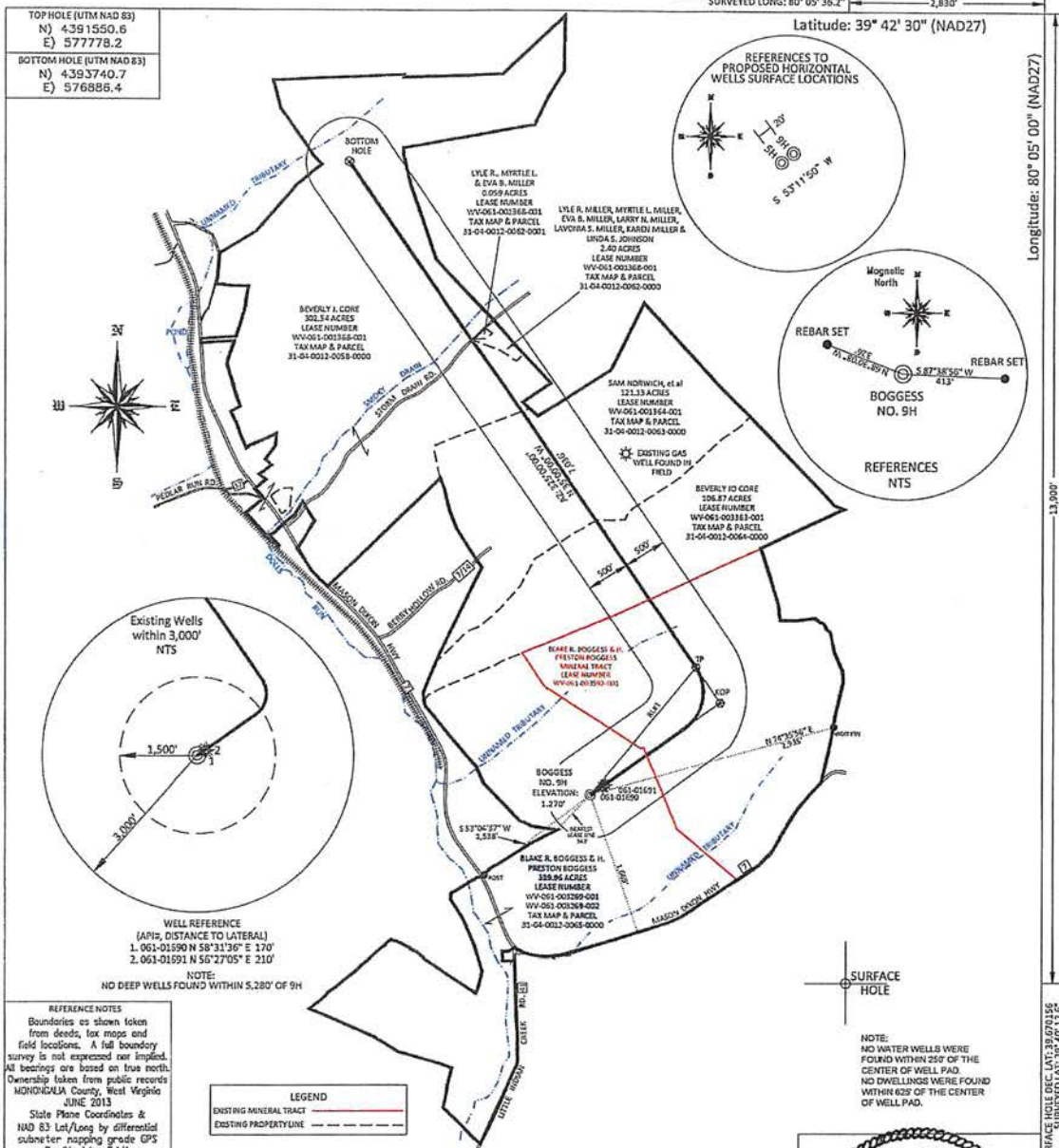

TOP HOLE (UTM NAD 83)
N) 4391550.8
E) 577778.2

BOTTOM HOLE (UTM NAD 83)
N) 4393740.7
E) 576886.4

Latitude: 39° 42' 30" (NAD27)
Longitude: 80° 05' 00" (NAD27)

Surface Hole Dec. Long: 80 093382
Surveyed Long: 80° 05' 36.2"

Surface Hole Lat: 39 40 14.6
Surveyed Lat: 39° 40' 12.6"

Existing Wells within 3,000' NTS

WELL REFERENCE (API, DISTANCE TO LATERAL)
1. 061-01590 N 58°31'36" E 170'
2. 061-01591 N 50°27'05" E 210'

NOTE:
NO DEEP WELLS FOUND WITHIN 5,280' OF 9H

REFERENCE NOTES
Boundaries as shown taken from deeds, tax maps and field locations. A full boundary survey is not expressed nor implied. All bearings are based on true north. Ownership taken from public records MONONGALIA County, West Virginia, JUNE 2013. State Plane Coordinates & NAD 83 Lat/Long by differential submeter mapping grade GPS. Drafted by: EAH.

LEGEND
EXISTING MINERAL TRACT
EXISTING PROPERTY LINE

I, THE UNDERSIGNED, HEREBY CERTIFY THAT THIS PLAT IS CORRECT TO THE BEST OF MY KNOWLEDGE AND BELIEF AND SHOWS ALL THE INFORMATION REQUIRED BY LAW AND THE REGULATIONS ISSUED AND PRESCRIBED BY THE DEPARTMENT OF ENVIRONMENTAL PROTECTION.

Signed: *[Signature]*

L.L.S. #2124: Ernest J. Benchek III



FILE #: NEE14

DRAWING #: 2459

SCALE: PLAT: 1" = 1600'
TICK MARK: 1" = 2000'

MINIMUM DEGREE OF ACCURACY: 1/200

PROVEN SOURCE OF ELEVATION: SUBMETER MAPPING GRADE GPS

DATE: JUNE 1, 2015

OPERATOR'S WELL #: BOGGESS NO. 9H

API WELL #: 47 61
STATE COUNTY PERMIT

WELL TYPE: Oil Waste Diposal Production Deep
 Gas Liquid Injection Storage Shallow

WATERSHED: DUNKARD CREEK

COUNTY/DISTRICT: MONONGALIA / CLAY

SURFACE OWNER: BLAKE R. & PRESTON H. BOGGESS

OIL & GAS ROYALTY OWNER: BLAKE R. & PRESTON H. BOGGESS

LEASE NUMBERS:

DRILL CONVERT DRILL DEEPER REDRILL FRACTURE OR STIMULATE
PLUG OFF FORMATION PERFORATE NEW FORMATION PLUG & ABANDON
CLEAN OUT & REPLUG OTHER CHANGE (SPECIFY):

TARGET FORMATION: MARCELLUS

WELL OPERATOR: NORTHEAST NATURAL ENERGY LLC
ADDRESS: 707 VIRGINIA STREET EAST, SUITE 1200
CITY: CHARLESTON STATE: WV ZIP CODE: 25301

ESTIMATED DEPTH: TVD PILOT: 8,500'
TMD: 16,605' TVD HORIZ: 8,092'

DESIGNATED AGENT: JOHN ADAMS
ADDRESS: 707 VIRGINIA STREET EAST, SUITE 1200
CITY: CHARLESTON STATE: WV ZIP CODE: 25301

Received
Office of Oil & Gas
JUL 14 2015

11/06/2015

WELL NAME: BOGGESS NO. 9H
OSAGE WV

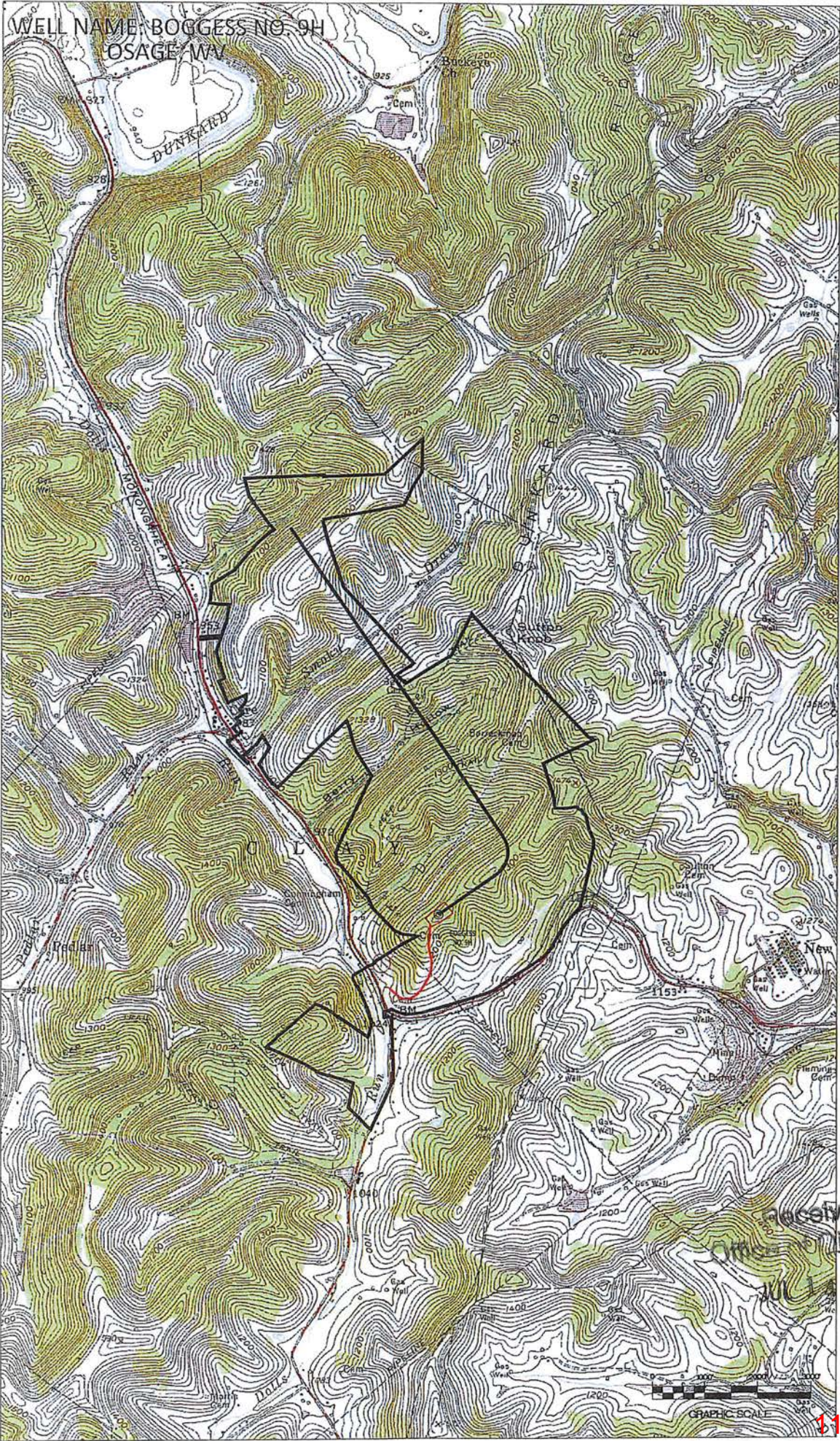

Received
Oil & Gas
JUL 1 2015

11/06/2015

Job Number:
Company: Northeast Natural Energy
Lease/Well: Boggess 9H
Location: Boggess
Rig Name: Pioneer 63
State/County: WV/ Mon
Country: US
API Number:



Elevation (To MSL): 1268.00 ft
RKB: 18.00 ft
Projection System: US State Plane 1983
Projection Group: West Virginia Northern Zone
Projection Datum: GRS80
Magnetic Declination: -8.96
Grid Convergence: -0.37791 W
Date: Monday, May 18, 2015

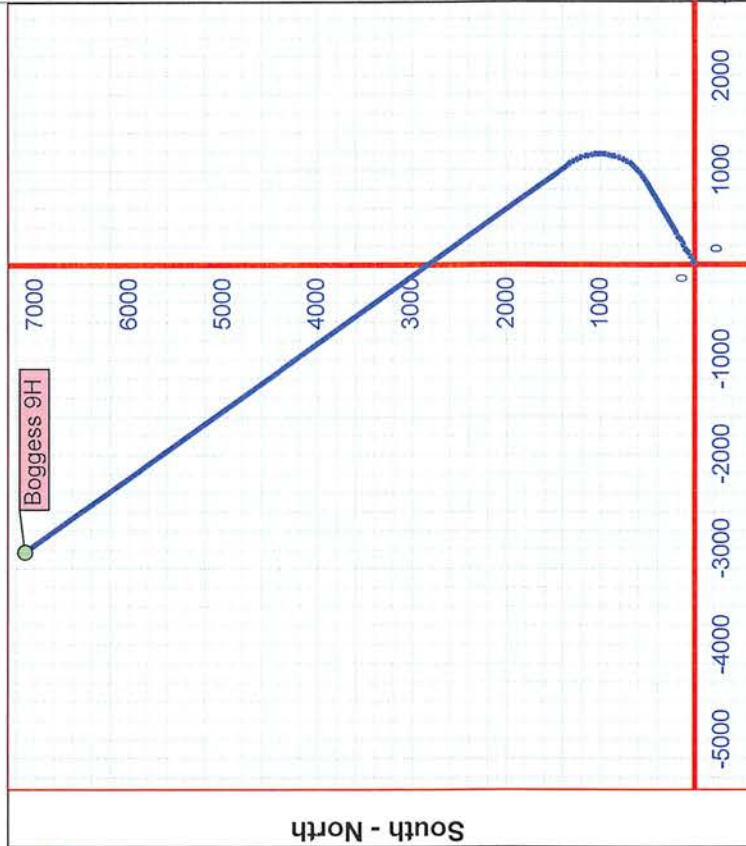
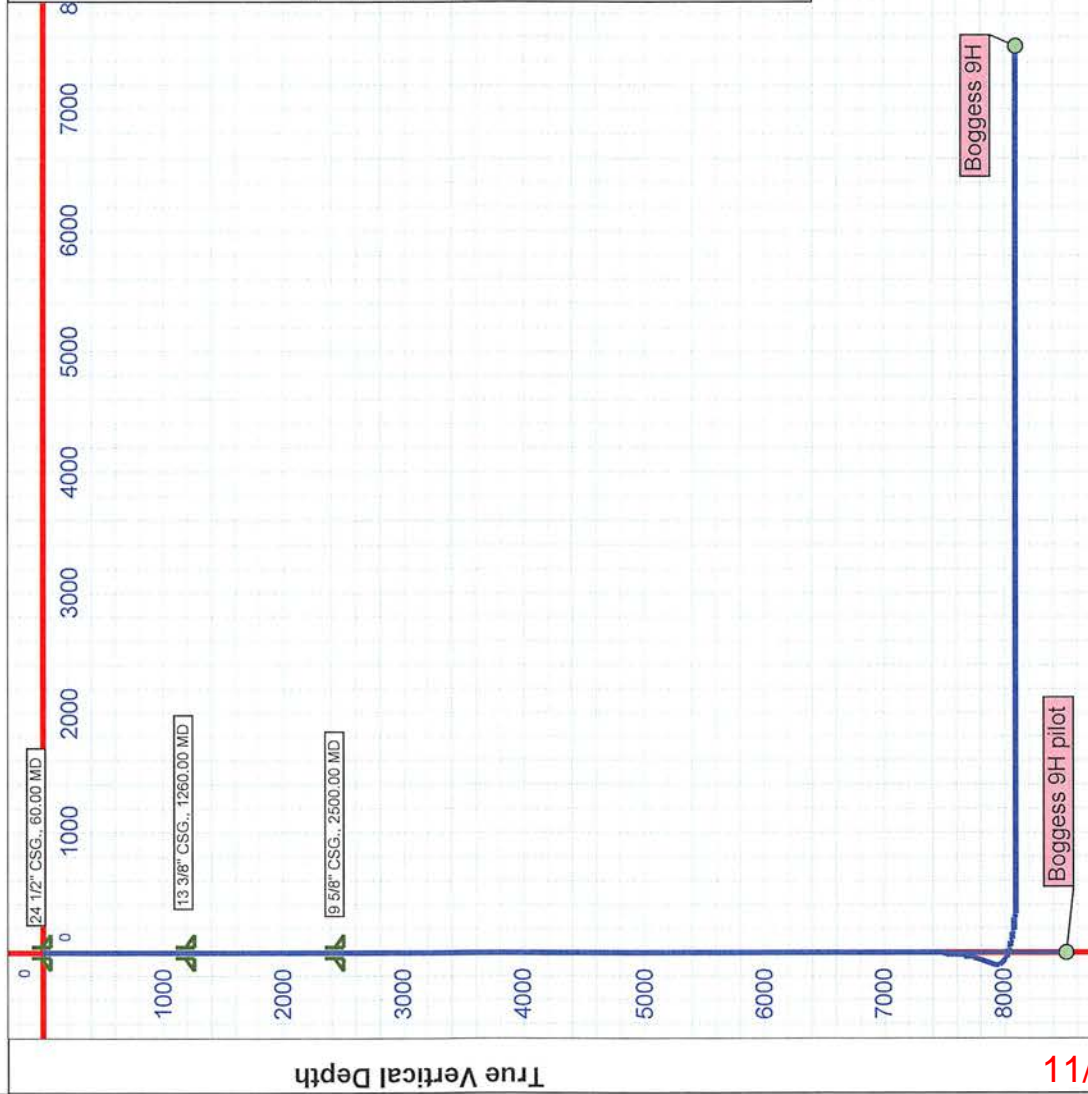

West - East

MD	TVD	West - East
KOP	7,200	Tully
LP	9,543	Hamilton
TD	16,605	Upper Marcellus
Pilot	8,500	Lower Marcellus
		Onondaga
		Oriskany
		Helderburg
		End Helderburg
		7,840
		7,904
		8,011
		8,056
		8,114
		8,139
		8,270
		8,500

Vertical Section (1000 Ft/Div) VSP: 324.00°

3

Well Work

A(1.0) Description of Drilling Operations

The Boggess 9H well will be drilled on air to an approximate depth of 7,840' TVD/MD. A pilot hole will then be drilled on synthetic based mud to an approximate depth of 8,500' and plugged back with solid cement to the KOP at approximately 7,200' TVD. The well will then be horizontally drilled on synthetic based mud from the KOP to approximately 8,092' TVD / 16,605' MD along a 325 degree azimuth.

A(1.1) Anticipated Equipment/Materials

During the drilling of a horizontal Marcellus gas well the following equipment and materials could be on the drilling location:

Equipment / Materials	Potential Hazard
Double Stand Drilling Rig	Medical, Fire/Explosion, Spill/Release
Mud Pumps	Medical, Fire/Explosion, Spill/Release
Mud Tanks	Medical, Fire/Explosion, Spill/Release
Fork Lift	Medical, Fire/Explosion, Spill/Release
Excavator	Medical, Fire/Explosion, Spill/Release
Diesel Tank	Medical, Fire/Explosion, Spill/Release
Diesel Fuel	Medical, Fire/Explosion, Spill/Release
Generators	Medical, Fire/Explosion, Spill/Release
Air Compressor	Medical, Fire/Explosion
Light Tower	Medical, Fire/Explosion, Spill/Release
Frac Tanks (mud, cement additives,	Medical, Fire/Explosion, Spill/Release
Drilling Mud Additives	Medical, Fire/Explosion, Spill/Release

Received
Office of Oil & Gas
JUL 14 2015

A(2.0) Description of Completions Operations

The Boggess 9H well will be completed using a multi-stage / high-rate slickwater fracture treatment using sand as a proppant. The First Stage will be initiated via pressurization against a burst disc ran in the production casing string and perforated by pumping down guns on wireline. Subsequent stages will also be perforated with pumped down guns ran on wireline. Individual stages will be isolated with composite frac plugs. Maximum pump rate during any stage will be 110 BPM with a maximum allowable surface pressure of 9,500 PSI. Composite bridge plugs will be set at the end of the last stage to isolate the treated formation. After the fracture treatment, composite frac plugs will be drilled out using a service rig and/or snubbing unit.

A(2.1) Anticipated Equipment/Materials

During the completion of a horizontal Marcellus gas well the following equipment and materials could be on the drilling location:

Equipment / Materials	Potential Hazard
Approximately 10 - 15 Pump Trucks	Medical, Fire/Explosion, Spill/Release
2 Blender Trucks	Medical, Fire/Explosion, Spill/Release
Belt Truck	Medical, Fire/Explosion, Spill/Release
Perforation Truck	Medical, Fire/Explosion, Spill/Release
Crane	Medical, Fire/Explosion, Spill/Release
Sand Tanks	Medical, Fire/Explosion, Spill/Release
Frac Tanks	Medical, Fire/Explosion, Spill/Release
Man Lift	Medical, Fire/Explosion, Spill/Release
Acid Truck	Medical, Fire/Explosion, Spill/Release
Fork Lift	Medical, Fire/Explosion, Spill/Release

Gel Truck	Medical, Fire/Explosion, Spill/Release
Communications Truck	Medical, Fire/Explosion, Spill/Release
Diesel Truck	Medical, Fire/Explosion, Spill/Release
Diesel Fuel	
80/90 wt gear oil	Medical, Fire/Explosion, Spill/Release
5/40 motor oil	Medical, Fire/Explosion, Spill/Release
Antifreeze	Medical, Fire/Explosion, Spill/Release
Ethylene Glycol	Medical, Fire/Explosion, Spill/Release
Tri-Ethylene Glycol	Medical, Fire/Explosion, Spill/Release
Frac Sand	Medical, Fire/Explosion, Spill/Release
Hydrochloric Acid (HCl)	Medical, Fire/Explosion, Spill/Release
Friction Reducer	Medical, Fire/Explosion, Spill/Release
Gelling Agents	Medical, Fire/Explosion, Spill/Release
Biocide	Medical, Fire/Explosion, Spill/Release
Scale Inhibitor	Medical, Fire/Explosion, Spill/Release
Iron Control	Medical, Fire/Explosion, Spill/Release
Gel Breaker Agent	Medical, Fire/Explosion, Spill/Release
Corrosion Inhibitor	Medical, Fire/Explosion, Spill/Release

Received
Office of Oil & Gas
JUL 14 2015

A(3.0) Description of Production Operations

During the production phase, the well stream will flow through buried, welded piping to Gas Production Units. At this point, the gas will be separated from the water and sent through a meter to a sales pipeline. The water will be piped and stored in above ground tanks on the well site. Well pressures and flow rates will be monitored and recorded to ensure proper facility operation. All facilities will be installed according to industry standards and will have appropriate safety systems in place.

A(3.1) Anticipated Equipment/Materials

Production

Equipment / Materials	Potential Hazard
Well Head	Medical, Fire/Explosion, Spill/Release
Buried Flow Line	Medical, Fire/Explosion, Spill/Release
Sand Separator	Medical, Fire/Explosion, Spill/Release
Gas Processing Unit	Medical, Fire/Explosion, Spill/Release
Water Tanks	Medical, Fire/Explosion, Spill/Release
Condensate Tank	Medical, Fire/Explosion, Spill/Release
Water Truck Hauling & Hook Up Equipment	Medical, Fire/Explosion, Spill/Release
Pig Launcher	Medical, Fire/Explosion, Spill/Release

Received
Office of Oil & Gas
JUL 14 2015

11/06/2015

M & R Station

Equipment / Materials	Potential Hazard
Flowline	Medical, Fire/Explosion, Spill/Release
Pig Receiver	Medical, Fire/Explosion, Spill/Release
Two Phase Separator	Medical, Fire/Explosion, Spill/Release
Filter Units	Medical, Fire/Explosion, Spill/Release
Heater Unit	Medical, Fire/Explosion, Spill/Release
Dehydration Tower	Medical, Fire/Explosion, Spill/Release
50 – 100 Barrel Water Tank	Medical, Fire/Explosion, Spill/Release
Meter House	Medical, Fire/Explosion, Spill/Release
Meter Skid	Medical, Fire/Explosion, Spill/Release

Received
Office of Oil & Gas
JUL 14 2015

11/06/2015

B DISTRIBUTION OF THE SITE SAFETY PLAN

Copies of this Plan will be located at NNE's corporate office building in Charleston, West Virginia, its field office in Morgantown, West Virginia, with the Designated Response Coordinators and field operation sites when applicable. This Plan may be accessed electronically by all NNE employees on the company's shared drive/share point. All NNE employees are to abide by the provisions of this Plan and are required to participate in its implementation. This Plan will also be shared with external entities such as the Monongalia County Office of Emergency Management within at least seven (7) days prior to earth disturbance and/or well work.

Efforts will be made to familiarize police, fire departments, emergency response teams and the County Emergency Management Coordinator with the layout of the well site, the properties and dangers associated with the equipment and materials that are on site, places where personnel would normally be working, and the possible evacuation routes should an emergency occur.

Received
Office of Oil & Gas
JUL 14 2015

11/06/2015

4

Chemical Inventory & Material Safety Data Sheets ("MSDS")

Received
Office of Oil & Gas
JUL 14 2015

11/06/2015

A Material Safety Data Sheets (“MSDS”)

MSDS Sheets will be provided upon request on a CD or USB drive.

B Location of MSDS

MSDS sheets will be kept in the company trailer during the drilling and completion phases of operation. Any Contractors that bring hazardous materials on site will provide MSDS for such. The onsite supervisor will be responsible for ensuring that all MSDS sheets are obtained and are easily accessible in case of an emergency.

C DRILLING MUD

1,500 bbl of 12.9 ppg synthetic drilling mud will be used along with the below listed chemicals. The mud will be kept in an open top above ground mud pit and circulated by nozzles and paddles.

Material	Unit	Amount
Barite	4000lb	9
Calcium Chloride Powder	50lb	200
Carbo Gel	50lb	60
Base Oil	1 gal	1440
Lime	50lb	69
Mil Sorb	50lb	87

5

Blow Out Preventer ("BOP") and Well Control

A BOP EQUIPMENT – DRILLING PHASE

From the shoe of the intermediate casing string (9-5/8") to KOP, the well will continue to be drilled on air. For this section, at a minimum, an 11" 3,000 PSI annular-type BOP will be utilized as a means of well control. Installation of this equipment will be dependent upon two different conditions...

- Should the top-hole drilling rig have a substructure large enough to sit upon a cellar, an 11" 5,000 PSI API flanged casing head will be welded onto the top of the intermediate casing string (9-5/8") below grade after it has been set and cement has cured for a minimum of 8 hours. It is upon this casing head that the annular-type BOP will be bolted and torqued to specification as a means of well control for the section.
- Should the top-hole drilling rig have a substructure too small to sit upon a cellar, the intermediate casing string (9-5/8") will be landed at surface and a screw-on or weld flange annular-type BOP will be used as a means of well control for the section. Under this scenario, a cellar will be installed around the wellbore after the top-hole rig is released from the pad. Once installed, an 11" 5,000 PSI API flanged casing head will then be welded onto the top of the intermediate casing string (9-5/8") below grade.

For the remainder of the drilling of the well on fluid; at a minimum and from bottom to top; an 11" 5,000 PSI kill spool, an 11" 5,000 PSI blind ram-type BOP, an 11" 5,000 PSI pipe ram-type BOP, and an 11" 5,000 PSI annular-type BOP will be bolted and torqued to specification upon the 11" 5,000 PSI casing head.

B PROCEDURE AND SCHEDULE FOR TESTING BOP

For the bottom and horizontal wellbore drilling phase, function testing of BOP equipment shall occur upon initial installation, weekly, and after each trip. Pressure testing of all BOP equipment shall occur upon initial installation and every twenty-one (21) days thereafter, should the well not be completed within that time. Annular preventers are to be tested to seventy percent (70%) of the rated capacity and ram preventers should be tested to eighty percent (80%) of the rated capacity according to the following procedure;

- The WV DEP Regional Oil and Gas Inspector will be notified 24 hrs. in advance of the pressure testing of all BOP equipment.
- For the testing of the 3,000 PSI annular-type BOP before drilling through the shoe of the intermediate casing string to KOP, a cup-type tester will be lowered into the intermediate casing (9-5/8") or a plug-type tester will be inserted into the

casing head if installed. After a successful function test, the annular BOP will be closed around drill pipe and the void between the cup or plug will be pressurized using fluid as a medium. This shall consist of a minimum five minute low pressure (300 PSI maximum) test, and a thirty minute high pressure (2,100 PSI minimum) test. Annular preventer and valves shall be tested from the direction they are exposed to wellbore pressure. A successful test shall consist of less than a 10% bleed off after buildup over the entire duration of the low/high test period.

- For the testing of the BOP stack from KOP to TD of the well, a plug-type tester will be placed into the bowl of the 11" 5M x 9-5/8" casing head. After a successful functional test, all rams, valves, TIW valves, chokes, and annular preventers will be pressure tested from the direction they are subjected to wellbore pressure. The annular preventer will be tested by pressurization around drill pipe using water as a medium and subject to a minimum five minute low pressure (300 PSI maximum) test, and a minimum thirty minute high pressure (2,100 PSI minimum for 3M equipment, 3,500 PSI minimum for 5M equipment) test. Rams, valves, TIW, and choke components shall be tested using water as a medium and subject to a minimum five minute low pressure (300 PSI maximum) test, and a minimum thirty minute high pressure (2,400 PSI minimum for 3M equipment, 4,000 PSI minimum for 5M equipment) test. Each individual component must pass its respective test before drilling may commence. A successful test shall consist of less than a 10% bleed off after buildup over the entire duration of the low/high test period.

C ASSEMBLY INSTALLATION SCHEDULE

- During top hole operations a 11" 5,000 PSI API flanged casing head will be welded onto the top of the intermediate casing string (9-5/8") below grade and an 11" 3,000 PSI annular-type BOP will be used to KOP
- From curve to TD the following will be added to the flanged casing;
11" 5,000 PSI kill spool, 11" 5,000 PSI blind ram-type BOP, 11" 5,000 PSI pipe ram-type BOP, and 11" 5,000 PSI annular-type BOP 11" 5,000 PSI casing head.

D PERSONNEL WITH WELL CONTROL TRAINING

Throughout operations, the following Northeast Natural Energy representatives shall have and maintain IADC well control certification:

- Jay Hewitt – Drilling Manager
- Ian Costello – Completions Engineer
- Ryan Warner – Production Engineer
- Any onsite consultant hired to oversee drilling or completions operations

E SYSTEM OF MAINTAINING DETAILED RECORDS

A detailed Driller's Log shall be maintained, including but not limited to, lost circulation, the presence of hydrogen sulfide gas, fluid entry, kicks, and abnormal pressures.

F NOTIFICATION OF THE OFFICE OF OIL AND GAS

The WV DEP Office of Oil and Gas will be immediately notified of the presence of hydrogen sulfide gas above 10 ppm, significant kicks, or blow-out events.

G WELL HEAD ASSEMBLY

A 5,000 PSI production tree will be placed upon the tubing spool after the drill out process. This unit will consist of, at a minimum and from bottom to top; one flanged 2-1/16" 5,000 PSI gated master valve, a studed three-way tee, a flanged 2-1/16" 5,000 PSI gated swab valve, and a 5,000 PSI flanged tree cap. The side outlet of the studed three-way tee shall include a flanged 2-1/16" 5,000 PSI gated wing valve. A schematic of the proposed wellhead and tree assembly is attached for reference.

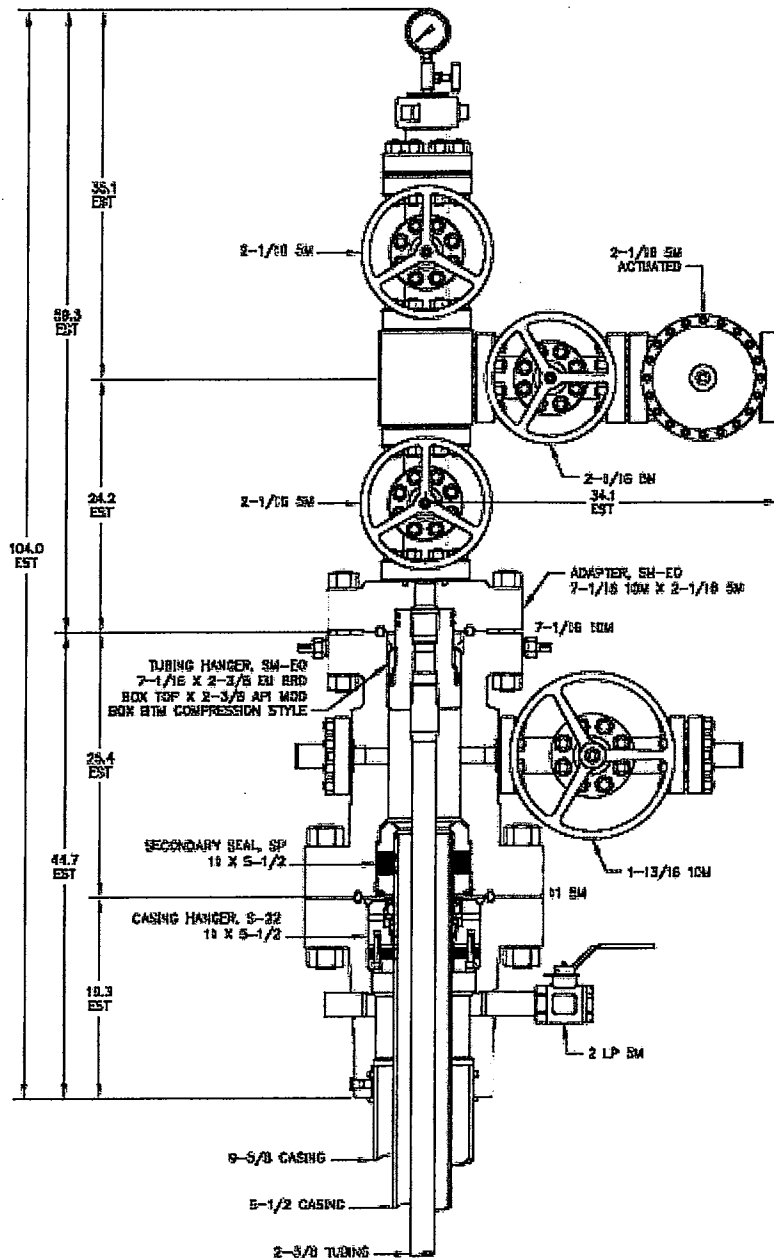

H WELL KILLING PROCEDURE

An oil-based synthetic drilling fluid will be utilized for the bottom and horizontal sections of the well. A total onsite volume of 1,600 Bbls (1.5 times the hole volume) will be maintained at 12.5 ppg. Enough weighting material, in the form of barite, will be kept onsite to increase the density of the entire volume of drilling mud by 1.0 ppg. This constitutes enough weighting material to initiate a 16 ppg slug, should a kick be encountered.

Dual-purpose paddle style mixing/reserve tanks will be used for the blending of mud additives and weighting material. A minimum of two units will be employed, with the final number based upon the drilling contractor selected.

The well will be drilled in an overbalanced manner to maintain control over formation fluids. Should a kick be detected, the well will be killed by either the IADC approved "Driller's Method" or "Wait and Weight" method. Bottomhole pressure will be calculated from SIDPP obtained post-kick, and the drilling fluid density will be increased by adding barite to the system and circulated throughout the wellbore when using the "Wait and Weight" method. After circulation with either method, the well will then be checked for flow, and if none is detected, then drilling operations will resume.

6

Hydrogen Sulfide ("H₂S")

A DETECTION, MONITORING AND WARNING EQUIPMENT

Based upon previous experience and history in the area, no H₂S is expected to be encountered during the drilling or completion activities of the Boggess 9H. As a means of additional protection, mud loggers will be utilized during the drilling process to monitor any gas stream from the well through the flowline during the bottom and horizontal sections. Additional portable detection equipment shall be available on or near potential sources of explosive or hydrogen sulfide gases on the pad throughout all operations. Monitoring equipment shall be calibrated by and in accordance with the supplying contractor's guidelines. Detection of either shall sound an alarm which notifies personnel to shut in the well(s) and evacuate to the predetermined safe zone immediately.

B H₂S TRAINING

A safe zone upwind and away from the well will be established at the beginning of each tour. Personnel are trained to evacuate the well and gather at this safe zone immediately at the first sound of an H₂S explosive gas alarm.

When in a historically known area, or after H₂S is first detected, operations will halt, evacuation procedures will be followed, and all personnel will be trained for detailed H₂S protocols before operations begin or resume.

C NOTIFYING THE OFFICE OF OIL AND GAS

In the event that H₂S is encountered, after all personnel have gathered in the safe zone, the onsite supervisor will take a head count, and then proper offsite notifications shall be made. The DEP Office of Oil and Gas will be notified by a phone call to both the local inspector and the emergency number.

D PROTECTION ZONES

A wind sock and/or flags will be utilized on location to identify wind direction, and safe zone upwind and away from the well will be established at the beginning of each tour. Personnel are trained to evacuate the well and gather at this safe zone immediately at the first sound of an H₂S explosive gas alarm.

E LIST OF PERSONAL PROTECTIVE EQUIPMENT (“PPE”)

Since drilling in a historically known area to not contain H₂S through the intervals drilled, H₂S specific PPE will not be kept on site. Centralized H₂S alarms, and supplemental personal alarms, will be maintained and used throughout the drilling and completion process. Personnel on site will be notified to cease the current operation safely, shut-in all wells on the pad, and evacuate all personnel to the pre-determined safe zone at the first signal of H₂S from these alarms. It is at this time that NNE personnel would assess the hazards, and bring in H₂S specialists and PPE to mitigate the situation. Normal work would return to the pad after all personnel passed a specific H₂S training and were equipped with the proper PPE.

7

Flaring

A FLARING PLAN

Post frac, a system of 2" and 3" Figure 1502 integrated-hammer pup joints will be assembled from the wellhead to a 5,000 PSI plug catcher and choke manifold. The choke manifold shall consist of two parallel adjustable chokes to control the initial flow of the well. Using the same construction iron, from the choke manifold, flow will enter a high capacity temporary production unit. The liquid fraction from the well will be diverted to gas buster equipped frac- tanks on location. All or part of the gas fraction from the well will be diverted to a thirty foot flare stack approximately 150' downwind of the wellhead. Any gas not diverted to a flare line shall be diverted to sales.

Iron pipe used in the flow/flare line assembly shall be banded at the joints with chain or steel cable. The flow/flare assembly shall be anchored in place by attachment to concrete blocks at vendor recommended intervals.

The flare stack will be equipped with an electronic ignition system, and a minimum of two backup ignition sticks will be kept on location at all times.

All gas diverted through the choke manifold shall either be burned through the flare stack or sent to sales. The local fire department will be given prior notice of the window in which gas flaring is to occur. They will also be notified immediately prior to lighting the flare, if possible, otherwise, as soon after lighting the flare as possible.

A 50' circumference shall be maintained around the flare stack which is to be kept free of flammable materials at all times prior to and during the flaring of any gas.

It is expected to flare the gas fraction of the well stream for a one week period.

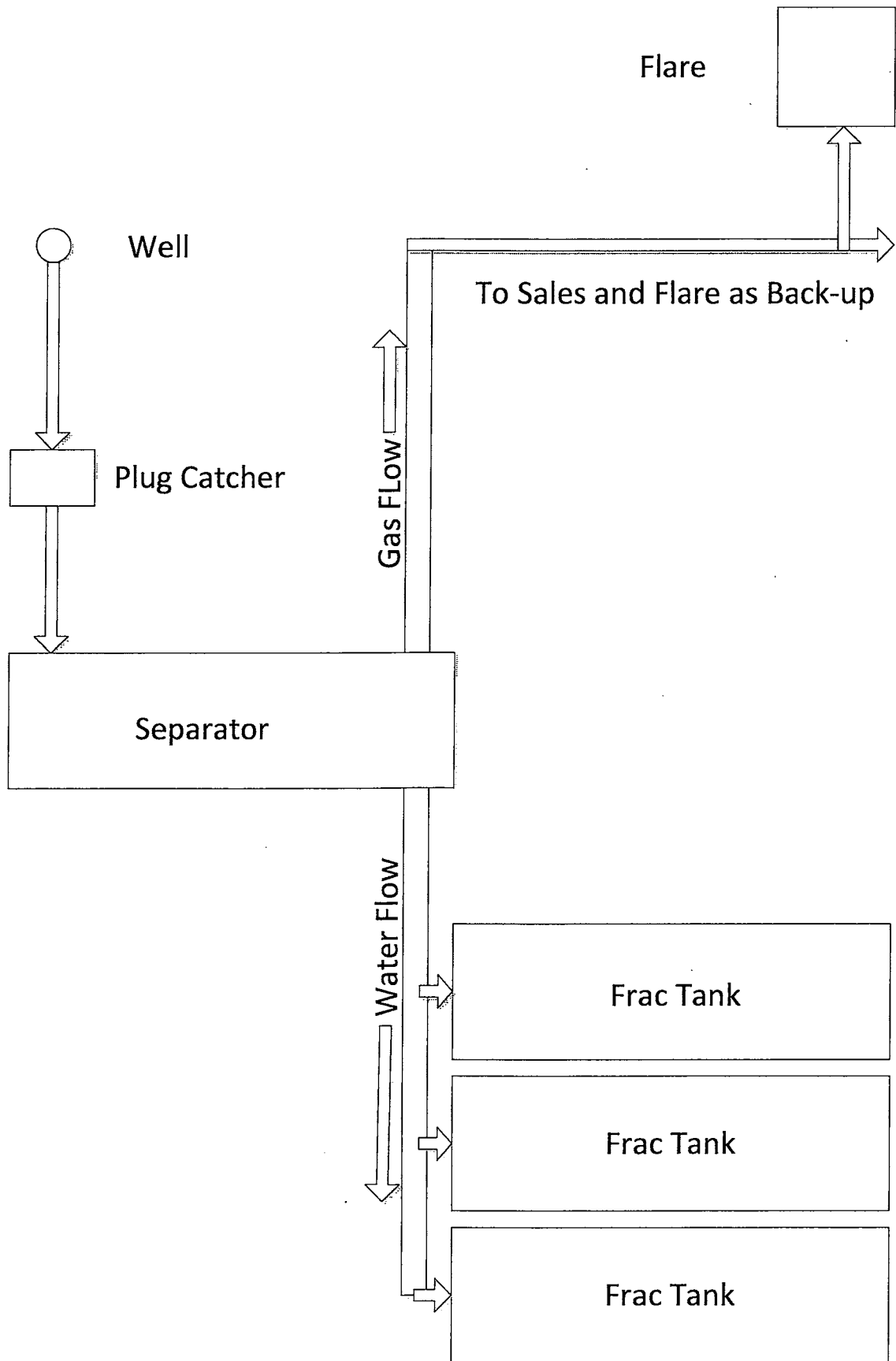

8

Collision Avoidance Safeguards, Practices and Standards

Scope of Work:

To ensure that wells are drilled in a safe manner that mitigates the risk of underground collisions on multi-well pads. Key portions of work will be described including roles, responsibilities and steps taken when returning to pads with existing producing or stimulated wells.

Definitions:

- 1) Proposed Wellbore- Involves sections of the vertical top-hole, the KOP, the lateral landing, and the lateral drilling to the total measured depth TMD.
- 2) Nudge- Technique generally used in the vertical top-hole section. The well path is nudged from vertical to pass areas of possible magnetic interferences and to reduce the risk of collision by maintaining separation with other wellbores.
- 3) KOP- Kick off Point. Diverting a well path from one trajectory to another
- 4) MWD- Measurement While Drilling
- 5) LWD- Logging While Drilling
- 6) EM - Electromagnetic Telemetry
- 7) SF- Separation Factor or Clearance Factor:
$$SF^* = CC \div [UR_{ref} + UR_{off}]$$

CC - Well separation distance (center to center of wellbores)
UR_{ref} – radius ellipse of uncertainty on reference well
UR_{off} – radius ellipse of uncertainty on offset well
Note: ellipses are half-axes or radii.

*Calculation options may be considered
- 8) TMD- Total Measured Depth
- 9) Gyro – High accuracy well bore survey instrument unaffected by magnetic interference.
- 10) QC / QA – Quality Control and Quality Assurance
- 11) HSE – Health Safety and the Environment
- 12) UBHO Sub – Universal Bottom Hole Orientation Sub

Established descriptions of risk:

- | | | |
|--------------------|---------|--------------------------|
| 1) SF ≤ 1.0 | Level 1 | Extreme collision risk |
| 2) SF = 1.0 to 1.5 | Level 2 | High collision risk |
| 3) SF = 1.5 to 2.0 | Level 3 | Moderate collision risk |
| 4) SF > 2.0 | Level 4 | Low to no collision risk |

*Please see attached directional schematic.

Well Planning:

Prior to drilling any well, a directional plan will be developed to ensure that the well is properly placed with consideration to permits, lease limitations and future drilling considerations. The well should be planned to maintain a SF of ≥ 2.0 whenever possible. If a SF of <2.0 is encountered, additional risk mitigation steps may be required such as downhole mechanical barriers and increased survey frequency.

Survey Protocol:

When drilling wells on a pad without producing or stimulated wells, surveys will be taken every 500' in the vertical portion of the wellbore.

When drilling wells on pads with producing or stimulated wells, the survey frequency will be at a minimum of every 250' and will be increased as needed.

Tool Alignment Procedure:

All work groups responsible for the placement of the wellbore share responsibility in ensuring accuracy. The Company Representative, Directional Drilling Supervisor and Gyro Supervisor are all responsible for the alignment of the UBHO Sub and the motor to ensure that azimuthal directional is correct. All parties should visually verify the orientation of the shoe and agree upon a coordinate system and reference point. When possible, MWD tools will be used to minimize risk of incorrect orientation.

Directional Planning and Controls – Vertical Wellbore:

When drilling on pads without producing or stimulated wells, all wells should be planned with a minimum SF ≥ 1.5 . Surveys should be taken at intervals of 500' to record the well path as it is drilled but the frequency can be increased if needed.

Drilling parameters should be held constant for the vertical portions of all wells to ensure the natural drilling path is similar for all wells on the pad.

Following the drilling of the vertical section of the wellbore, a gyro survey will be taken. Anti-collision software will be used to analyze this data to ensure safe wellbore spacing. Internally, Hawkeye will be used for tracking and planning 3D wellbore geometry and, as a redundancy, the directional company will utilize their own software to confirm results.

If drilling wells on a pad with existing producing or completed wells, additional steps in directional planning may be required. If possible, all additional wells to an active pad should be planned with a SF ≥ 2.0 . If a well cannot be planned in such a manner, additional means of risk mitigation will be considered including nudging the wellbores, use of MWD/EM, down hole barriers in at risk wells and increased survey frequency.

Directional Planning and Controls – Curve and Lateral Wellbore:

While drilling the curve and lateral portions of the wellbores, MWD technology will be used to ensure the well path is drilled according to the drilling plan and the state permit. Azimuth, gamma ray and other data will be collected and transmitted to surface. The information will be analyzed by the Directional Drilling Contractor, Company Representative, Drilling Manager and Geologist to ensure the quality of the data and proper interpretation.

The path of the well being drilled will be monitored in relationship to all adjacent wells to ensure adequate SF is maintained during the vertical, curve and horizontal portions of the wellbore.

Other Data:

Prior to drilling new wells on a pad, a site overview with the wellhead arrangement will be developed. Among the information that should be included is API number, surface footage separation and wellbore status. Additionally, all survey data for each existing well will be compiled for use in well planning.

Contingency Plans:

The wellbore being drilled will be monitored in relation to existing wellbores. Should the active well approach an existing well and the SF be < 1.5 , drilling should be suspended until risks are mitigated by adjusting the directional plan, increasing survey frequency and verifying any necessary mechanical barriers are present in the adjacent wells. If a SF ≤ 1 is experienced, the WV DEP Office of Oil and Gas Regional Inspector will be immediately contacted.

Should a collision occur, the WV DEP Office of Oil and Gas Regional Inspector will be immediately contacted, drilling will be suspended and all existing wells will be monitored for integrity. If a loss of pressure control in any well is experienced, Wild Well Control, or another professional well control company, will be contracted for technical support and services. If there is not a loss of pressure control, a separate well work procedure will be developed to repair or plug and abandon the effected wells.

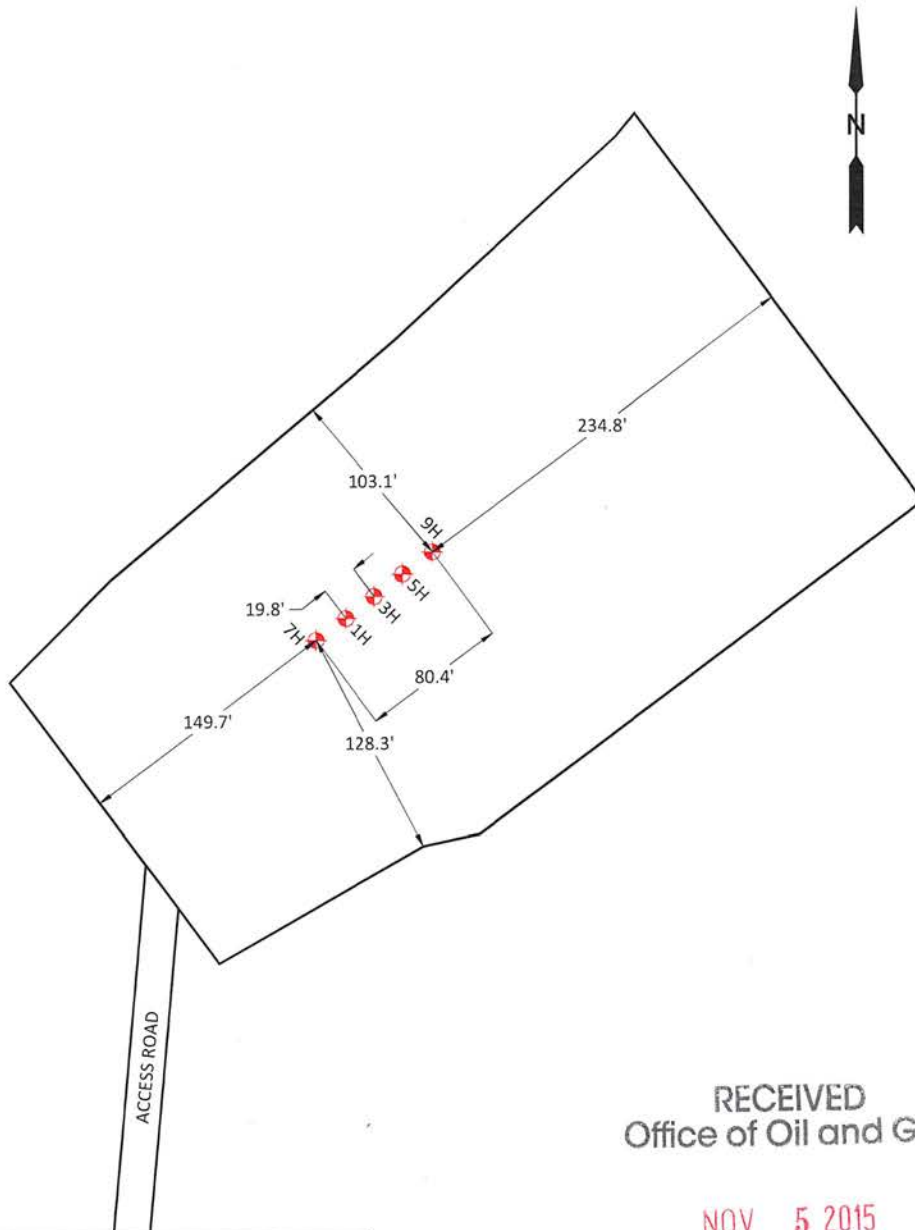

RECEIVED
Office of Oil and Gas

NOV 5 2015

WV Department of
Environmental Protection



SCALE BAR: 1"=100'



PREPARED FOR
NORTHEAST NATURAL ENERGY LLC
BOGCESS WELL PAD
CLAY DISTRICT, MONONGALIA COUNTY, WV

PREPARED BY
BOORD BENCHEK & ASSOC., INC.
ENGINEERING, SURVEYING, CONSTRUCTION AND
MINING SERVICES
SOUTHPOINTE, PA 15317 PHONE: 724-746-1055

LEGEND

-  =PROPOSED WELL
-  =EXISTING WELL

Well Number	API Number	Status
Boggess 5H	Permit Applied	Proposed
Boggess 9H	Permit Applied	Proposed

11/06/2015

Proposed: Boggess 5H & 9H
Northeast Natural Energy LLC



RECEIVED
Office of Oil and Gas
NOV 5 2015
WV Department of
Environmental Protection

11/06/2015

9

Deep Well Additional Requirements

A – ANTICIPATED DEPTHS

Freshwater	50' , 1,209'
Saltwater	1,784' – 2,435'
Oil and Gas	2,28'-3,392'; 8,011' – 8,114'
Hydrogen Sulfide	N/A*
Thief Zones	N/A*
High Pressure	N/A*
High Volume	N/A*

B – CASING AND CEMENTING PROGRAM

Type	Size	New or Used	Grade	Weight Per Foot	Footage: For Drilling	Intervals: Left in Well	Cement: Fill-Up (Cu. Ft.)
Conductor	24"	New	NA	94.71	60'	60'	GTS
Freshwater	13 3/8"	New	J-55	54.5	1,290'	1,260'	CTS
Coal							
Intermediate	9 5/8"	New	J-55	40	2,530'	2,500'	CTS
Production	5 1/2"	New	P-110	20	16,605'	16,575'	3,824 cu. ft

*This well will be drilled into the Helderburg formation for logging purposes only and will be plugged back to the KOP with solid cement.

Received
Office of Oil & Gas
JUL 14 2015

WELL NAME: BOGGESS NO. 9H
OSAGE, WV

4706101691

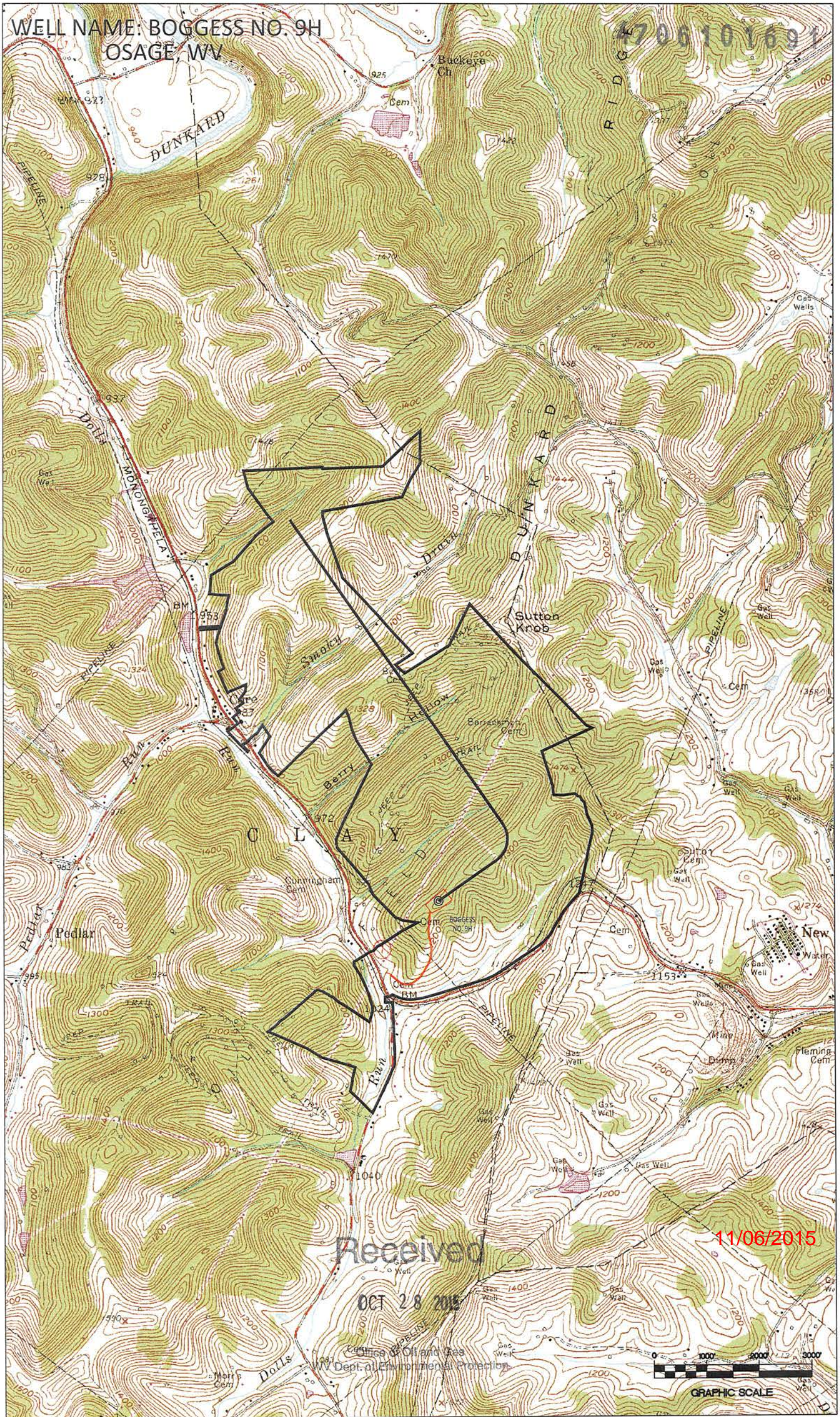

Received

OCT 28 2015

11/06/2015

Office of Oil and Gas
WV Dept. of Environmental Protection



SURFACE HOLE DEC. LONG: 80.093382
 SURVEYED LONG: 80° 05' 36.2"

Latitude: 39° 42' 30" (NAD27)

Longitude: 80° 05' 00" (NAD27)

TOP HOLE (UTM NAD 83)
 N) 4391550.6
 E) 577776.2

BOTTOM HOLE (UTM NAD 83)
 N) 4393740.7
 E) 576886.4

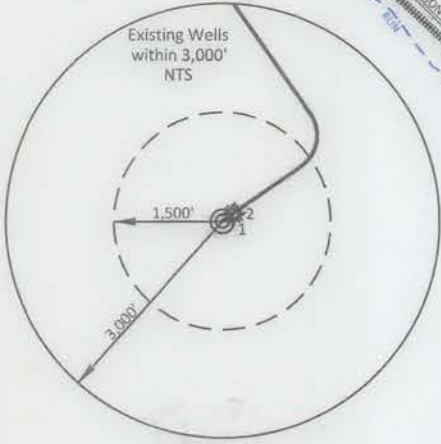
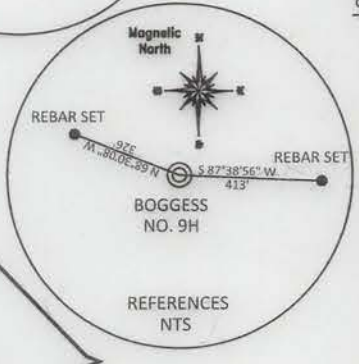
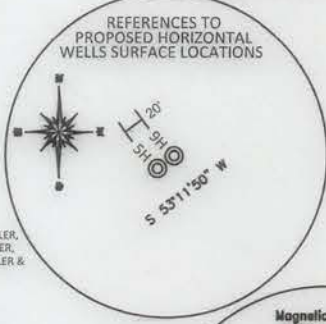
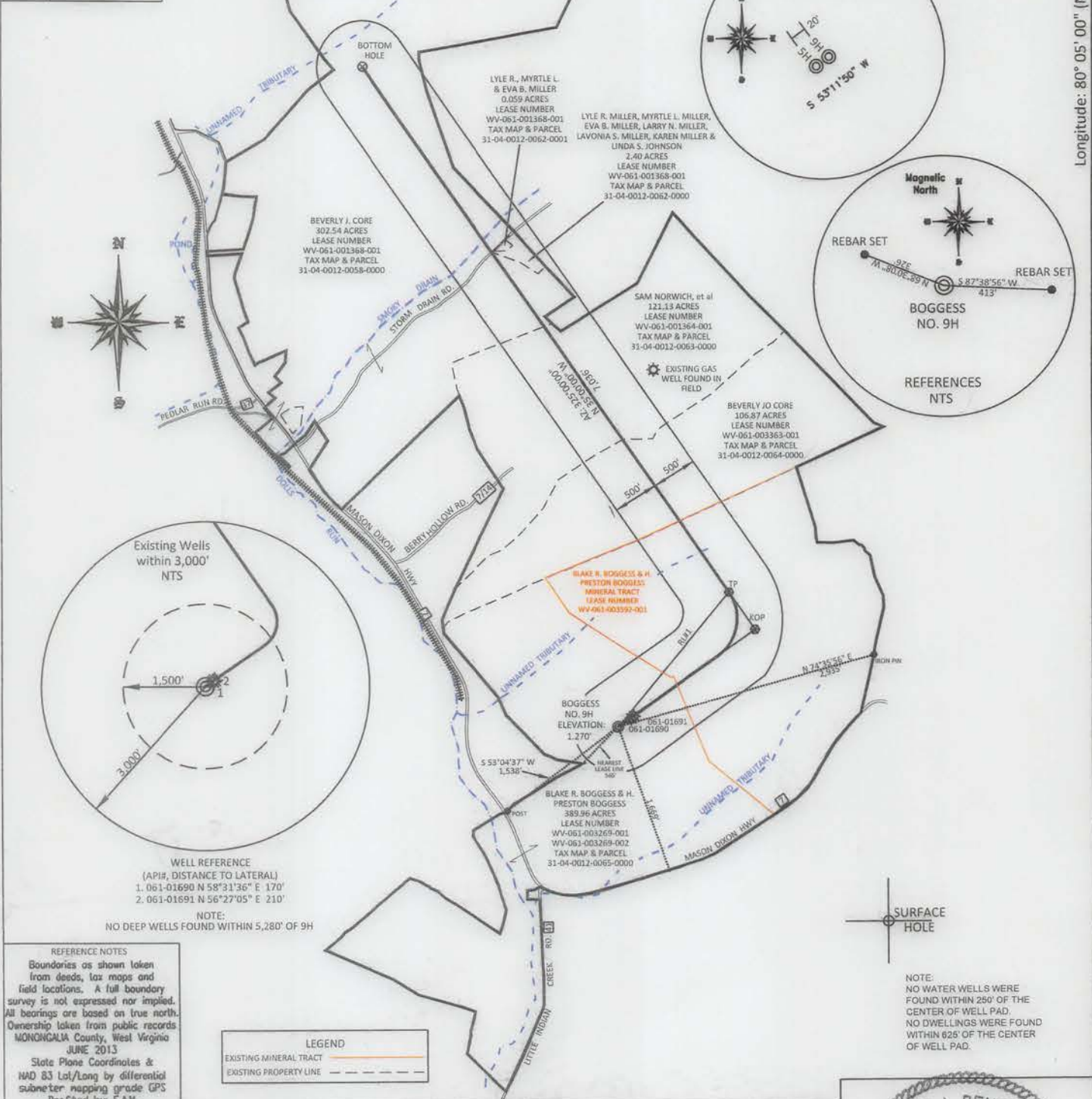

WELL REFERENCE
 (API#, DISTANCE TO LATERAL)
 1. 061-01690 N 58°31'36" E 170'
 2. 061-01691 N 56°27'05" E 210'

NOTE:
 NO DEEP WELLS FOUND WITHIN 5,280' OF 9H

REFERENCE NOTES
 Boundaries as shown taken from deeds, tax maps and field locations. A full boundary survey is not expressed nor implied. All bearings are based on true north. Ownership taken from public records MONONGALIA County, West Virginia JUNE 2013
 State Plane Coordinates & NAD 83 Lat/Long by differential submeter mapping grade GPS Drafted by: EAM

LEGEND
 EXISTING MINERAL TRACT
 EXISTING PROPERTY LINE

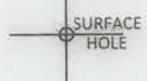

NOTE:
 NO WATER WELLS WERE FOUND WITHIN 200' OF THE CENTER OF WELL PAD.
 NO DWELLINGS WERE FOUND WITHIN 625' OF THE CENTER OF WELL PAD.

SURFACE HOLE DEC. LAT: 39.670156
 SURVEYED LAT: 39° 40' 12.6"

FILE #: NEE14
 DRAWING #: 2459
 SCALE: PLAT: 1" = 1600'
TICK MARK: 1" = 2000'
 MINIMUM DEGREE OF ACCURACY: 1/200
 PROVEN SOURCE OF ELEVATION: SUBMETER MAPPING GRADE GPS

I, THE UNDERSIGNED, HEREBY CERTIFY THAT THIS PLAT IS CORRECT TO THE BEST OF MY KNOWLEDGE AND BELIEF AND SHOWS ALL THE INFORMATION REQUIRED BY LAW AND THE REGULATIONS ISSUED AND PRESCRIBED BY THE DEPARTMENT OF ENVIRONMENTAL PROTECTION.

Signed: [Signature]
 L.L.S. #2124: Ernest J. Benchek III

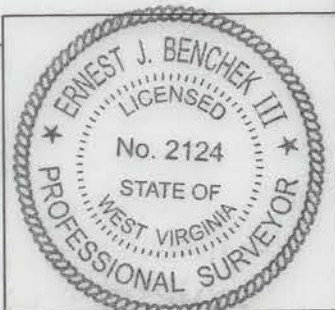

(+) DENOTES LOCATION OF WELL ON UNITED STATES TOPOGRAPHIC MAPS WVDEP
 OFFICE OF OIL & GAS
 601 57TH STREET
 CHARLESTON, WV 25304

Well Type: Oil Waste Disposal Production Deep
 Gas Liquid Injection Storage Shallow

WATERSHED: DUNKARD CREEK
 COUNTY/DISTRICT: MONONGALIA / CLAY
 SURFACE OWNER: BLAKE R. & PRESTON H. BOGCESS
 OIL & GAS ROYALTY OWNER: BLAKE R. & PRESTON H. BOGCESS
 LEASE NUMBERS: _____

DATE: JUNE 1, 2015
 OPERATOR'S WELL #: BOGCESS NO. 9H
 API WELL #: 47 61 01691
 STATE COUNTY PERMIT
 ELEVATION: 1,268'
 QUADRANGLE: OSAGE, WV
 ACREAGE: 389.96 +/-
 ACREAGE: 922.959 +/-

11/06/2015

DRILL CONVERT DRILL DEEPER REDRILL FRACTURE OR STIMULATE
 PLUG OFF FORMATION PERFORATE NEW FORMATION PLUG & ABANDON
 CLEAN OUT & REPLUG OTHER CHANGE (SPECIFY): _____

TARGET FORMATION: MARCELLUS ESTIMATED DEPTH: TMD: 16,605' TVD PILOT: 8,500' TVD HORIZ: 8,092'
 WELL OPERATOR: NORTHEAST NATURAL ENERGY LLC DESIGNATED AGENT: JOHN ADAMS
 ADDRESS: 707 VIRGINIA STREET EAST, SUITE 1200 ADDRESS: 707 VIRGINIA STREET EAST, SUITE 1200
 CITY: CHARLESTON STATE: WV ZIP CODE: 25301 CITY: CHARLESTON STATE: WV ZIP CODE: 25301

4706101691

WW-6A1

Operator's Well No. Bogges 9H

NNE Lease No.	Grantor, Lessor, etc.	Grantee, Lessee, etc.	Royalty	Book/Page	Tax Map & Parcel
WV-061-003269-001	BOGCESS, BLAKE R.	*Novus Exploration, LLCC	0.125 or greater	1399/010	8-12-65
WV-061-003269-002	BOGCESS, H. PRESTON	*Novus Exploration, LLCC	0.125 or greater	1399/006	8-12-65
WV-061-003592-001	SHUMAN, INC.	Northeast Natural Energy LLC	0.125 or greater	1526/462	8-12-65
WV-061-003363-001	BERNATOWICZ, JOYCE F., TRUSTEE OF DONALD F. FRAZEE TRUST	Northeast Natural Energy LLC	0.125 or greater	1502/564	8-12-64
WV-061-001364-001	PLATT, ROBERT G.	*Chesapeake Appalachia, LLC	0.125 or greater	1372/350	8-12-63
WV-061-001368-001	MYERS, JUNE C.	*Chesapeake Appalachia, LLC	0.125 or greater	1374/205	8-12-58
WV-061-003586-001	CORE, CHARLES	Northeast Natural Energy LLC	0.125 or greater	1523/710	12-58,62,62.1

*See Attachment

Received
Office of Oil & Gas
JUL 14 2015

11/06/2015

4706101691

Chesapeake Appalachia, LLC.



Northeast Natural Energy
Assignment
BK 120/769

Received
Office of Oil & Gas
JUL 14 2015

11/06/2015

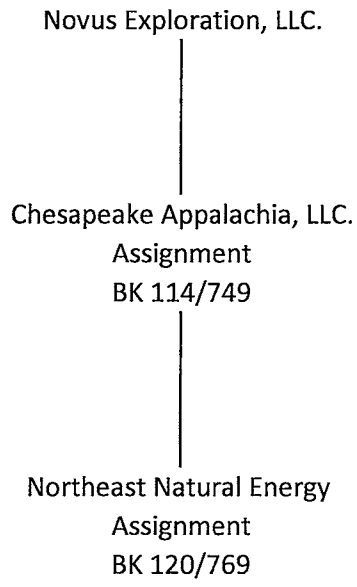

4706101691

STATE OF WEST VIRGINIA
DEPARTMENT OF ENVIRONMENTAL PROTECTION, OFFICE OF OIL AND GAS
NOTICE OF APPLICATION

Notice Time Requirement: notice shall be provided no later than the filing date of permit application.

Date of Notice: 6/4/2015 Date Permit Application Filed: 7/7/2015

Notice of:

- PERMIT FOR ANY WELL WORK
- CERTIFICATE OF APPROVAL FOR THE CONSTRUCTION OF AN IMPOUNDMENT OR PIT

Delivery method pursuant to West Virginia Code § 22-6A-10(b)

- PERSONAL SERVICE
- REGISTERED MAIL
- METHOD OF DELIVERY THAT REQUIRES A RECEIPT OR SIGNATURE CONFIRMATION

Pursuant to W. Va. Code § 22-6A-10(b) no later than the filing date of the application, the applicant for a permit for any well work or for a certificate of approval for the construction of an impoundment or pit as required by this article shall deliver, by personal service or by registered mail or by any method of delivery that requires a receipt or signature confirmation, copies of the application, the erosion and sediment control plan required by section seven of this article, and the well plat to each of the following persons: (1) The owners of record of the surface of the tract on which the well is or is proposed to be located; (2) The owners of record of the surface tract or tracts overlying the oil and gas leasehold being developed by the proposed well work, if the surface tract is to be used for roads or other land disturbance as described in the erosion and sediment control plan submitted pursuant to subsection (c), section seven of this article; (3) The coal owner, operator or lessee, in the event the tract of land on which the well proposed to be drilled is located [sic] is known to be underlain by one or more coal seams; (4) The owners of record of the surface tract or tracts overlying the oil and gas leasehold being developed by the proposed well work, if the surface tract is to be used for the placement, construction, enlargement, alteration, repair, removal or abandonment of any impoundment or pit as described in section nine of this article; (5) Any surface owner or water purveyor who is known to the applicant to have a water well, spring or water supply source located within one thousand five hundred feet of the center of the well pad which is used to provide water for consumption by humans or domestic animals; and (6) The operator of any natural gas storage field within which the proposed well work activity is to take place. (c)(1) If more than three tenants in common or other co-owners of interests described in subsection (b) of this section hold interests in the lands, the applicant may serve the documents required upon the person described in the records of the sheriff required to be maintained pursuant to section eight, article one, chapter eleven-a of this code. (2) Notwithstanding any provision of this article to the contrary, notice to a lien holder is not notice to a landowner, unless the lien holder is the landowner. W. Va. Code R. § 35-8-5.7.a requires, in part, that the operator shall also provide the Well Site Safety Plan ("WSSP") to the surface owner and any water purveyor or surface owner subject to notice and water testing as provided in section 15 of this rule.

Application Notice WSSP Notice E&S Plan Notice Well Plat Notice is hereby provided to:

SURFACE OWNER(s)

Name: See Attachment
Address: _____

Name: _____
Address: _____

SURFACE OWNER(s) (Road and/or Other Disturbance)

Name: See Attachment
Address: _____

Name: _____
Address: _____

SURFACE OWNER(s) (Impoundments or Pits)

Name: _____
Address: _____

COAL OWNER OR LESSEE

Name: See Attachment
Address: _____

COAL OPERATOR

Name: _____
Address: _____

SURFACE OWNER OF WATER WELL AND/OR WATER PURVEYOR(s)

Name: See Attachment
Address: _____

OPERATOR OF ANY NATURAL GAS STORAGE FIELD

Name: _____
Address: _____

Received
Office of Oil & Gas
JUL 14 2015

*Please attach additional forms if necessary

4706101691

Notice is hereby given:

Pursuant to West Virginia Code § 22-6A-10(b), notice is hereby given that the undersigned well operator has applied for a permit for well work or for a certificate of approval for the construction of an impoundment or pit.

This Notice Shall Include:

Pursuant to W. Va. Code § 22-6A-10(b), this notice shall include: (1) copies of the application; (2) the erosion and sediment control plan required by section seven of this article; and (3) the well plat.

Pursuant to W. Va. Code § 22-6A-10(f), this notice shall include: (1) a statement of the time limits for filing written comments; (2) who may file written comments; (3) the name and address of the secretary for the purpose of filing the comments and obtaining additional information; and (4) a statement that the persons may request, at the time of submitting written comments, notice of the permit decision and a list of persons qualified to test water.

Pursuant to W. Va. Code R. § 35-8-5.7.a, the operator shall provide the Well Site Safety Plan to the surface owner and any water purveyor or surface owner subject to notice and water testing as provided in section 15 of this rule.

Pursuant to W. Va. Code R. § 35-8-15.2.c, this notice shall: (1) contain a statement of the surface owner's and water purveyor's right to request sampling and analysis; (2) advise the surface owner and water purveyor of the rebuttable presumption for contamination or deprivation of a fresh water source or supply; advise the surface owner and water purveyor that refusal to allow the operator to conduct a pre-drilling water well test constitutes a method to rebut the presumption of liability; (3) advise the surface owner and water purveyor of his or her independent right to sample and analyze any water supply at his or her own expense; advise the surface owner and water purveyor whether or not the operator will utilize an independent laboratory to analyze any sample; and (4) advise the surface owner and or water purveyor that he or she can obtain from the Chief a list of water testing laboratories in the subject area capable of and qualified to test water supplies in accordance with standard acceptable methods.

Additional information related to horizontal drilling may be obtained from the Secretary, at the WV Department of Environmental Protection headquarters, located at 601 57th Street, SE, Charleston, WV 25304 (304-926-0450) or by visiting www.dep.wv.gov/oil-and-gas/pages/default.aspx.

Well Location Restrictions

Pursuant to W. Va. Code § 22-6A-12, Wells may not be drilled within two hundred fifty feet measured horizontally from any existing water well or developed spring used for human or domestic animal consumption. The center of well pads may not be located within six hundred twenty-five feet of an occupied dwelling structure, or a building two thousand five hundred square feet or larger used to house or shelter dairy cattle or poultry husbandry. This limitation is applicable to those wells, developed springs, dwellings or agricultural buildings that existed on the date a notice to the surface owner of planned entry for surveying or staking as provided in section ten of this article or a notice of intent to drill a horizontal well as provided in subsection (b), section sixteen of this article was provided, whichever occurs first, and to any dwelling under construction prior to that date. This limitation may be waived by written consent of the surface owner transmitted to the department and recorded in the real property records maintained by the clerk of the county commission for the county in which such property is located. Furthermore, the well operator may be granted a variance by the secretary from these distance restrictions upon submission of a plan which identifies the sufficient measures, facilities or practices to be employed during well site construction, drilling and operations. The variance, if granted, shall include terms and conditions the department requires to ensure the safety and protection of affected persons and property. The terms and conditions may include insurance, bonding and indemnification, as well as technical requirements. (b) No well pad may be prepared or well drilled within one hundred feet measured horizontally from any perennial stream, natural or artificial lake, pond or reservoir, or a wetland, or within three hundred feet of a naturally reproducing trout stream. No well pad may be located within one thousand feet of a surface or ground water intake of a public water supply. The distance from the public water supply as identified by the department shall be measured as follows: (1) For a surface water intake on a lake or reservoir, the distance shall be measured from the boundary of the lake or reservoir. (2) For a surface water intake on a flowing stream, the distance shall be measured from a semicircular radius extending upstream of the surface water intake. (3) For a groundwater source, the distance shall be measured from the wellhead or spring. The department may, in its discretion, waive these distance restrictions upon submission of a plan identifying sufficient measures, facilities or practices to be employed during well site construction, drilling and operations to protect the waters of the state. A waiver, if granted, shall impose any permit conditions as the secretary considers necessary. (c) Notwithstanding the foregoing provisions of this section, nothing contained in this section prevents an operator from conducting the activities permitted or authorized by a Clean Water Act Section 404 permit or other approval from the United States Army Corps of Engineers within any waters of the state or within the restricted areas referenced in this section. (d) The well location restrictions set forth in this section shall not apply to any well on a multiple well pad if at least one of the wells was permitted prior to the effective date of this article. (e) The secretary shall, by December 31, 2012, report to the Legislature on the noise, light, dust and volatile organic compounds generated by the drilling of horizontal wells as they relate to the well location restrictions regarding occupied dwelling structures pursuant to this section. Upon a finding, if any, by the secretary that the well location restrictions regarding occupied dwelling structures are inadequate or otherwise require alteration to address the items

Received
Office of Oil & Gas
Jul 14 2015

11/06/2015

examined in the study required by this subsection, the secretary shall have the authority to propose for promulgation legislative rules establishing guidelines and procedures regarding reasonable levels of noise, light, dust and volatile organic compounds relating to drilling horizontal wells, including reasonable means of mitigating such factors, if necessary.

Water Well Testing:

Pursuant to West Virginia Code § 22-6A-10(d), notification shall be made, with respect to surface landowners identified in subsection (b) or water purveyors identified in subdivision (5), subsection (b) of this section, of the opportunity for testing their water well. The operator shall provide an analysis to such surface landowner or water purveyor at their request.

Water Testing Laboratories:

Pursuant to West Virginia Code § 22-6A-10(i), persons entitled to notice pursuant to subsection (b) of this section may contact the department to ascertain the names and locations of water testing laboratories in the subject area capable and qualified to test water supplies in accordance with standard accepted methods. In compiling that list of names the department shall consult with the state Bureau for Public Health and local health departments. A surface owner and water purveyor has an independent right to sample and analyze any water supply at his or her own expense. The laboratory utilized by the operator shall be approved by the agency as being certified and capable of performing sample analyses in accordance with this section.

Rebuttable Presumption for Contamination or Deprivation of a Fresh Water Source or Supply:

W. Va. Code § 22-6A-18 requires that (b) unless rebutted by one of the defenses established in subsection (c) of this section, in any action for contamination or deprivation of a fresh water source or supply within one thousand five hundred feet of the center of the well pad for horizontal well, there is a rebuttable presumption that the drilling and the oil or gas well or either was the proximate cause of the contamination or deprivation of the fresh water source or supply. (c) In order to rebut the presumption of liability established in subsection (b) of this section, the operator must prove by a preponderance of the evidence one of the following defenses: (1) The pollution existed prior to the drilling or alteration activity as determined by a predrilling or prealteration water well test. (2) The landowner or water purveyor refused to allow the operator access to the property to conduct a predrilling or prealteration water well test. (3) The water supply is not within one thousand five hundred feet of the well. (4) The pollution occurred more than six months after completion of drilling or alteration activities. (5) The pollution occurred as the result of some cause other than the drilling or alteration activity. (d) Any operator electing to preserve its defenses under subdivision (1), subsection (c) of this section shall retain the services of an independent certified laboratory to conduct the predrilling or prealteration water well test. A copy of the results of the test shall be submitted to the department and the surface owner or water purveyor in a manner prescribed by the secretary. (e) Any operator shall replace the water supply of an owner of interest in real property who obtains all or part of that owner's supply of water for domestic, agricultural, industrial or other legitimate use from an underground or surface source with a comparable water supply where the secretary determines that the water supply has been affected by contamination, diminution or interruption proximately caused by the oil or gas operation, unless waived in writing by that owner. (f) The secretary may order the operator conducting the oil or gas operation to: (1) Provide an emergency drinking water supply within twenty-four hours; (2) Provide temporary water supply within seventy-two hours; (3) Within thirty days begin activities to establish a permanent water supply or submit a proposal to the secretary outlining the measures and timetables to be used in establishing a permanent supply. The total time in providing a permanent water supply may not exceed two years. If the operator demonstrates that providing a permanent replacement water supply cannot be completed within two years, the secretary may extend the time frame on case-by-case basis; and (4) Pay all reasonable costs incurred by the real property owner in securing a water supply. (g) A person as described in subsection (b) of this section aggrieved under the provisions of subsections (b), (e) or (f) of this section may seek relief in court... (i) Notwithstanding the denial of the operator of responsibility for the damage to the real property owner's water supply or the status of any appeal on determination of liability for the damage to the real property owner's water supply, the operator may not discontinue providing the required water service until authorized to do so by the secretary or a court of competent jurisdiction.

Written Comment:

Pursuant to West Virginia Code § 22-6A-11(a), all persons described in subsection (b), section ten of this article may file written comments with the secretary as to the location or construction of the applicant's proposed well work within thirty days after the application is filed with the secretary. All persons described in West Virginia Code § 22-6A-10(b) may file written comments as to the location or construction of the applicant's proposed well work to the Secretary at:

Chief, Office of Oil and Gas
Department of Environmental Protection
601 57th St. SE
Charleston, WV 25304
(304) 926-0450

Received
Office of Oil & Gas
JUL 14 2015

Such persons may request, at the time of submitting written comments, notice of the permit decision and a list of persons qualified to test water. **NOTE: YOU ARE NOT REQUIRED TO FILE ANY COMMENT.**

Time Limits and Methods for Filing Comments.

The law requires these materials to be served on or before the date the operator files its Application. You have **THIRTY (30) DAYS** after the filing date to file your comments. Comments must be filed in person or received in the mail by the Chief's office by the time stated above. You may call the Chief's office to be sure of the date. Check with your postmaster to ensure adequate delivery time or to arrange special expedited handling. If you have been contacted by the well operator and you have signed a "voluntary statement of no objection" to the planned work described in these materials, then the permit may be issued at any time.

Pursuant to West Virginia Code § 22-6A-11(c)(2), Any objections of the affected coal operators and coal seam owners and lessees shall be addressed through the processes and procedures that exist under sections fifteen, seventeen and forty, article six of this chapter, as applicable and as incorporated into this article by section five of this article. The written comments filed by the parties entitled to notice under subdivisions (1), (2), (4), (5) and (6), subsection (b), section ten of this article shall be considered by the secretary in the permit issuance process, but the parties are not entitled to participate in the processes and proceedings that exist under sections fifteen, seventeen or forty, article six of this chapter, as applicable and as incorporated into this article by section five of this article.

Comment Requirements

Your comments must be in writing and include your name, address and telephone number, the well operator's name and well number and the approximate location of the proposed well site including district and county from the application. You may add other documents, such as sketches, maps or photographs to support your comments.

Disclaimer: All comments received will be placed on our web site <http://www.dep.wv.gov/oil-and-gas/Horizontal-Permits/Pages/default.aspx> and the applicant will automatically be forwarded an email notice that such comments have been submitted. The applicant will be expected to provide a response to comments submitted by any surface owner, water purveyor or natural gas storage operator noticed within the application.

Permit Denial or Condition

The Chief has the power to deny or condition a well work permit. Pursuant to West Virginia Code § 22-6A-8(d), the permit may not be issued or be conditioned, including conditions with respect to the location of the well and access roads prior to issuance if the director determines that:

- (1) The proposed well work will constitute a hazard to the safety of persons;
- (2) The plan for soil erosion and sediment control is not adequate or effective;
- (3) Damage would occur to publicly owned lands or resources; or
- (4) The proposed well work fails to protect fresh water sources or supplies.

A permit may also be denied under West Virginia Code § 22-6A-7(k), the secretary shall deny the issuance of a permit if the secretary determines that the applicant has committed a substantial violation of a previously issued permit for a horizontal well, including the applicable erosion and sediment control plan associated with the previously issued permit, or a substantial violation of one or more of the rules promulgated under this article, and in each instance has failed to abate or seek review of the violation within the time prescribed by the secretary pursuant to the provisions of subdivisions (1) and (2), subsection (a), section five of this article and the rules promulgated hereunder, which time may not be unreasonable.

Pursuant to West Virginia Code § 22-6A-10(g), any person entitled to submit written comments to the secretary pursuant to subsection (a), section eleven of this article, shall also be entitled to receive from the secretary a copy of the permit as issued or a copy of the order modifying or denying the permit if the person requests receipt of them as a part of the written comments submitted concerning the permit application. Such persons may request, at the time of submitting written comments, notice of the permit decision and a list of persons qualified to test water.

Received
Office of Oil & Gas
JUL 14 2015

4706101691

WW-6A
(8-13)

API NO. 47- _____ -
OPERATOR WELL NO. Bogges 9H
Well Pad Name: Bogges

Notice is hereby given by:

Well Operator: Northeast Natural Energy LLC
Telephone: 304-241-5752, ext. 7108
Email: hmedley@nne-llc.com

Address: 707 Virginia Street E., Suite 1200
Charleston, WV 25301
Facsimile: 304-241-5972

Oil and Gas Privacy Notice:

The Office of Oil and Gas processes your personal information, such as name, address and telephone number, as part of our regulatory duties. Your personal information may be disclosed to other State agencies or third parties in the normal course of business or as needed to comply with statutory or regulatory requirements, including Freedom of Information Act requests. Our office will appropriately secure your personal information. If you have any questions about our use or your personal information, please contact DEP's Chief Privacy Officer at depprivacyofficer@wv.gov.

Helli M. Medley



Subscribed and sworn before me this 4th day of November 2015.

[Signature] Notary Public

My Commission Expires January 28, 2020

RECEIVED
Office of Oil and Gas
NOV 5 2015
WV Department of
Environmental Protection

11/06/2015

4706101691

Bogges 5H & 9H – Notice of Permit Modification Application – 2015-6-4

7011 0470 0002 7478 8468

U.S. Postal Service™	
CERTIFIED MAIL™ RECEIPT	
<i>(Domestic Mail Only; No Insurance Coverage Provided)</i>	
For delivery information visit our website at www.usps.com ®	
OFFICIAL USE	
Postage	\$ 595
Certified Fee	345
Return Receipt Fee (Endorsement Required)	280
Restricted Delivery Fee (Endorsement Required)	
Total Postage & Fees	\$ 1220

Postmark
or
MAIL & MORE™ CMRA
MORGANTOWN WV 26508

JUN 04 2015

Sent To	Mr. Chad C. Forman
Street, Apt. No.; or PO Box No.	1543 Mason Dixon Highway
City, State, ZIP+4	Core, WV 26541

PS Form 3800, August 2006 See Reverse for Instructions

Received
Office of Oil & Gas
JUL 14 2015

11/06/2015

4706101691

Bogges 5H & 9H – Notice of Permit Modification Application – 2015-6-4

7031 0470 0002 7478 8444

U.S. Postal Service™
CERTIFIED MAIL™ RECEIPT
(Domestic Mail Only; No Insurance Coverage Provided)

For delivery information visit our website at www.usps.com

OFFICIAL USE

Postage	\$ 595
Certified Fee	345
Return Receipt Fee (Endorsement Required)	280
Restricted Delivery Fee (Endorsement Required)	
Total Postage & Fees	\$ 1220

MAIL & MORE™ CMRA
MORGANTOWN WV 26606

Postmark
JUN 04 2015

Sent To
Street, Apt. No.,
or PO Box No. Mr. Blake R. Bogges
1584 Mason Dixon Highway
City, State, ZIP+4 Madsville, WV 26541

PS Form 3800, August 2006 See Reverse for Instructions

Received
Office of Oil & Gas
JUL 14 2015

11/06/2015

4706101691

Bogges 5H & 9H – Notice of Permit Modification Application – 2015-6-4

7011 0470 0002 7478 7959

U.S. Postal Service™
CERTIFIED MAIL™ RECEIPT
(Domestic Mail Only; No Insurance Coverage Provided)

For delivery information visit our website at www.usps.com

OFFICIAL USE

Postage	\$ 595
Certified Fee	345
Return Receipt Fee (Endorsement Required)	280
Restricted Delivery Fee (Endorsement Required)	
Total Postage & Fees	\$ 1220

MAIL & MORE - CMRA
MORGANTOWN, WV 26508

Postmark Here
JUN 04 2015

Sent To
Street, Apt. No.,
or PO Box No.
City, State, ZIP+4

Ms. Mary Jane Walls
3230 Mason Dixon Highway
Core, WV 26541

PS Form 3800, August 2006 See Reverse for Instructions

Received
Office of Oil & Gas
JUL 14 2015

11/06/2015

4706101691

Bogges 5H & 9H – Notice of Permit Modification Application – 2015-6-4

9962 848 2000 0440 TT02

U.S. Postal Service™
CERTIFIED MAIL™ RECEIPT
(Domestic Mail Only; No Insurance Coverage Provided)

For delivery information visit our website at www.usps.com

OFFICIAL USE

Postage	\$ 595	MAIL & MORE - CMRA MORGANTOWN, WV 26505 Postmark Here JUN 04 2015
Certified Fee	345	
Return Receipt Fee (Endorsement Required)	280	
Restricted Delivery Fee (Endorsement Required)		
Total Postage & Fees	\$ 1220	

Sent To
 Street, Apt. No., or PO Box No. Mr. & Mrs. Dave Jones
 3106 Little Indian Creek Road
 City, State, ZIP+4 Core, WV 26541

PS Form 3800, August 2006 See Reverse for Instructions

Received
Office of Oil & Gas
JUL 14 2015

11/06/2015

4706101691

Bogess 5H & 9H – Notice of Permit Modification Application – 2015-6-4

7011 0470 0002 7476 8437

U.S. Postal Service™
CERTIFIED MAIL™ RECEIPT
 (Domestic Mail Only; No Insurance Coverage Provided)

For delivery information visit our website at www.usps.com®

OFFICIAL USE

Postage	\$ 59.5	MAIL & MORE - CMRA 1100 CANTONWAY 28508 Morgantown, WV 26508	JUN 04 2015
Certified Fee	34.5		
Return Receipt Fee (Endorsement Required)	2.80		
Restricted Delivery Fee (Endorsement Required)			
Total Postage & Fees	\$ 122.0		

Sent To

Street, Apt. No., or PO Box No. Mr. Roy L. Eddy
 297 Stull Hollow Road
 City, State, ZIP+4 Madsville, WV 26541

PS Form 3800, August 2006 See Reverse for Instructions

Received
Office of Oil & Gas
JUL 14 2015

11/06/2015

4706101691

Bogges 5H & 9H – Notice of Permit Modification Application – 2015-6-4

7011 0470 0002 7478 8451

U.S. Postal Service™
CERTIFIED MAIL™ RECEIPT
(Domestic Mail Only; No Insurance Coverage Provided)

For delivery information visit our website at www.usps.com

OFFICIAL USE

Postage	\$ 6.35	MAIL & MORE - CMRA MORGANTOWN, WV 26508 <small>Postmark</small>
Certified Fee	3.45	
Return Receipt Fee (Endorsement Required)	2.80	
Restricted Delivery Fee (Endorsement Required)		
Total Postage & Fees	\$ 12.60	

JUN 04 2015

Sent To
 Street, Apt. No., or PO Box No. Mr. H. Preston Bogges
 City, State, ZIP+4 119 Pine Springs Drive, S.E.
 Copperhill, VA 24079

PS Form 3800, August 2006 See Reverse for Instructions

Received
Office of Oil & Gas
JUL 14 2015

11/06/2015

4706101691

Bogges 5H & 9H – Notice of Permit Modification Application – 2015-6-4

7011 0470 0002 7478 8475

U.S. Postal Service™
CERTIFIED MAIL™ RECEIPT
(Domestic Mail Only; No Insurance Coverage Provided)

For delivery information visit our website at www.usps.com

OFFICIAL USE

Postage	\$ 414
Certified Fee	345
Return Receipt Fee (Endorsement Required)	280
Restricted Delivery Fee (Endorsement Required)	
Total Postage & Fees	\$ 10.39

MAIL & MORE - CMRA
 POSTMARK
 WY 26508
 WY 26508
 JUN 04 2015

Sent To Consolidated Coal Company
 Engineering & Operations Support Coal

*Street, Apt. No.,
 or PO Box No.* Attn: Analyst
 CNX Center

City, State, ZIP+4 1000 Consol Energy Drive
 Canonsburg, PA 15317

PS Form 3800, August 2006 See Reverse for Instructions

Received
Office of Oil & Gas
JUL 14 2015

11/06/2015

4706101691

Bogges 5H & 9H – Notice of Permit Modification Application – 2015-6-4

7011 0470 0002 7478 8383

U.S. Postal Service™
CERTIFIED MAIL™ RECEIPT
(Domestic Mail Only; No Insurance Coverage Provided)

For delivery information visit our website at www.usps.com

OFFICIAL USE

Postage	\$ 4.14
Certified Fee	3.45
Return Receipt Fee (Endorsement Required)	2.80
Restricted Delivery Fee (Endorsement Required)	
Total Postage & Fees	\$ 10.39

MAIL & MORE™ CMRA
MORGANTOWN WV 26008

JUN 04 2015

Sent To
 Street, Apt. No.,
 or PO Box No. Murray Energy Corporation
 Attn: Alex P. O'Neill
 Coal, Oil & Gas Relations Manager
 City, State, ZIP+4 46226 National Road
 St. Clairsville, OH 43950

RS Form 3800, August 2006 See Reverse for Instructions

Received
Office of Oil & Gas
JUL 14 2015

11/06/2015

**Horizontal Natural Gas Well Work Permit
Application Notice By Publication**

Notice is hereby given:

Pursuant to West Virginia Code 22-6A-10(e) prior to filing an application for a permit for a horizontal well the applicant shall publish in the county in which the well is located or is proposed to be located a Class II legal advertisement.

Paper: The Dominion Post

Public Notice Date: 5/12/2015; 5/19/2015

The following applicant intends to apply for a horizontal natural well work permit which disturbs three acres or more of surface excluding pipelines, gathering lines and roads or utilizes more than two hundred ten thousand gallons of water in any thirty day period.

Applicant: Northeast Natural Energy LLC **Well Number:** Boguess 5H & 9H

Address: 707 Virginia Street East, Suite 1200
Charleston, WV 25301

Business Conducted: Natural gas production.

Location –

State: West Virginia County: Monongalia
District: Clay Quadrangle: Osage, WV
UTM Coordinate NAD83 Northing: 4391546.9 (Boguess 5H); 4391550.6 (Boguess 9H)
UTM coordinate NAD83 Easting: 577773.3 (Boguess 5H); 577778.2 (Boguess 9H)
Watershed: Dunkard Creek

Coordinate Conversion:

To convert the coordinates above into longitude and latitude, visit: http://tagis.dep.wv.gov/convert/llutm_conus.php

Electronic notification:

To receive an email when applications have been received or issued by the Office of Oil and Gas, visit <http://www.dep.wv.gov/insidedep/Pages/DEPMailingLists.aspx> to sign up.

Reviewing Applications:

Copies of the proposed permit application may be reviewed at the WV Department of Environmental Protection headquarters, located at 601 57th Street, SE Charleston, WV 25304 (304-926-0450). Full copies or scans of the proposed permit application will cost \$15, whether mailed or obtained at DEP headquarters. Copies may be requested by calling the office or by sending an email to DEP.oog@wv.gov.

Submitting Comments:

Comments may be submitted online at <https://apps.dep.wv.gov/oog/comments/comments.cfm>, or by letter to Permit Review, Office of Oil and Gas, 601 57th Street, SE Charleston, WV 25304. Please reference the county, well number, and operator when using this option.

Regardless of format for comment submissions, they must be received no later than thirty days after the permit application is received by the Office of Oil and Gas.

For information related to horizontal drilling visit: www.dep.wv.gov/oil-and-gas/pages/default.aspx

Received
Office of Oil & Gas
JUL 14 2015

PUBLISHER'S CERTIFICATE

4706101691

vs.

Horizontal Natural Gas Well Work Permit Application Notice By Publication

May 12, 19

Thereby given:
West Virginia Code 22-6A-10(e) prior to filing an application for a permit for a horizontal well the applicant in the county in which the well is located or is proposed to be located a Class II legal advertisement.

Dominion Post

Effective Date: 5/12/2015; 5/19/2015

The applicant intends to apply for a horizontal natural well work permit which disturbs three acres or more (including pipelines, gathering lines and roads or utilizes more than two hundred ten thousand gallons of thirty day period.

Applicant: Northeast Natural Energy LLC Well Number: Boggess 5H & 9H

Address: 7 Virginia Street East, Suite 1200

City: Charleston, WV 25301

Production: Produced: Natural gas production.

State: West Virginia County: Monongalia

District: Clay Quadrangle: Osage

JTM Coordinate NAD83 Northing: 4391546.9 (Boggess 5H); 4391550.6 (Boggess 9H)

JTM Coordinate NAD83 Easting: 577773.3 (Boggess 5H); 577778.2 (Boggess 9H)

Watershed: Dunkard Creek

Conversion:
Convert the coordinates above into longitude and latitude, visit: http://tagis.dep.wv.gov/convert/lutm_conus.

Notification:
Email when applications have been received or issued by the Office of Oil and Gas, visit <http://www.nrsidedep/Pages/DEPMailingLists.aspx> to sign up.

Applications:
A proposed permit application may be reviewed at the WV Department of Environmental Protection located at 601 57th Street, SE Charleston, WV 25304 (304-926-0450). Full copies or scans of a permit application will cost \$15, whether mailed or obtained at DEP headquarters. Copies may be calling the office or by sending an email to DEP.oog@wv.gov.

Comments:
Comments may be submitted online at <https://apps.dep.wv.gov/oog/comments/comments.cfm>, or by letter to the Office of Oil and Gas, 601 57th Street, SE Charleston, WV 25304. Please reference the county and operator when using this option.

For format for comment submissions, they must be received no later than thirty days after the permit received by the Office of Oil and Gas.

For information related to horizontal drilling visit: www.dep.wv.gov/oil-and-gas/pages/default.aspx

STATE OF WEST VIRGINIA
COUNTY OF MONONGALIA

I, Eric Wilson Advertising Director of

THE DOMINION POST, a newspaper of general circulation

published in the City of Morgantown, County and State

of the aforesaid, do hereby certify that the annexed

Legal Notice

was published in the said THE DOMINION POST once a week

for 3 successive weeks commencing on the

11th day of May, 2015 and ending on the

19th day of May, 2015

The publisher's fee for said publication is \$470.80

Given under my hand this 19th day of

May, 2015

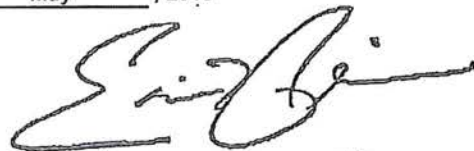

(SEAL)

Advertising Director of THE DOMINION POST

Subscribed and sworn to before me this 19th

day of May, 2015

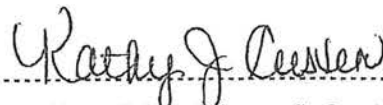

Notary Public of Monongalia County, W. Va.

My commission expires on the 13th day of April

2024

Office of Oil & Gas



11/06/2015



NORTHEAST NATURAL ENERGY, LLC

Location: Monongalia County, WV

Field: Monongalia

Facility: Boggess Pad

Slot: Slot 09

Well: Boggess 9H

Wellbore: Boggess 9H PWB



This reference wellbore is Boggess 9H PWB Well.
 True vertical depths are referenced to Rig on Slot 09 (RT).
 Measured depths are referenced to Rig on Slot 09 (RT).
 North Reference: Grid north.
 Rig on Slot 09 (RT) to Mean Sea Level: 1258 feet.
 Slot: True distance.
 Depth was to feet.
 Mean Sea Level to Grid (at Slot 09): -1258 feet.
 Coordinates are in feet referenced to Grid.
 Created by: gshubert on 09/09/2015

Facility Name	Grid East (US Ft)	Grid North (US Ft)	Latitude	Longitude
Boggess Pad	807448.600	429249.600	39°42'12.460"N	80°52'35.037"W
Slot	Local N (ft)	Local E (ft)	Local S (ft)	Local W (ft)
Slot 09	361.10	47.99	1601529.500	429785.700

Name	WOB (ft)	Local E (ft)	Local N (ft)	Grid East (US Ft)	Grid North (US Ft)	Latitude	Longitude
Boggess Pad Top	7524.00	-31.15	-47.99	1601441.35	429144.60	39°42'12.460"N	80°52'35.037"W
Boggess Pad Bottom	7892.00	-31.15	-47.99	1601441.35	429144.60	39°42'12.460"N	80°52'35.037"W
Boggess Pad Center	7708.00	-31.15	-47.99	1601441.35	429144.60	39°42'12.460"N	80°52'35.037"W
Boggess Pad Edge	8134.47	842.00	219.54	1602231.28	429249.60	39°42'12.460"N	80°52'35.037"W
Boggess Pad Top	8134.28	842.00	147.48	1602231.28	429249.60	39°42'12.460"N	80°52'35.037"W
Boggess Pad Center	8064.00	-31.15	-47.99	1601441.35	429144.60	39°42'12.460"N	80°52'35.037"W

Design Comment	MD (ft)	Inc (ft)	As (ft)	TVD (ft)	Locat (ft)	Locat E (ft)	Locat N (ft)	DLS (1100ft)	VS (ft)
Tie On	0.00	0.00	57.507	2535.00	0.00	0.00	0.00	0.00	0.00
KOP	2535.00	0.00	57.507	2535.00	0.00	0.00	0.00	0.00	0.00
End of Build	2851.80	10.008	57.507	2846.02	27.07	43.00	0.00	0.00	-2.28
End of Tangent	7800.10	10.008	57.507	7524.51	893.73	1403.27	0.00	0.00	-72.78
LP	8708.26	90.000	325.000	8074.00	1471.49	1229.57	10.00	0.00	500.12
BHL	15744.87	90.000	325.000	8074.00	7235.54	-2898.47	0.00	0.00	7536.73

Design Comment	MD (ft)	Inc (ft)	As (ft)	TVD (ft)	Locat (ft)	Locat E (ft)	Locat N (ft)	DLS (1100ft)	VS (ft)
Tie On	0.00	0.00	57.507	2535.00	0.00	0.00	0.00	0.00	0.00
KOP	2535.00	0.00	57.507	2535.00	0.00	0.00	0.00	0.00	0.00
End of Build	2851.80	10.008	57.507	2846.02	27.07	43.00	0.00	0.00	-2.28
End of Tangent	7800.10	10.008	57.507	7524.51	893.73	1403.27	0.00	0.00	-72.78
LP	8708.26	90.000	325.000	8074.00	1471.49	1229.57	10.00	0.00	500.12
BHL	15744.87	90.000	325.000	8074.00	7235.54	-2898.47	0.00	0.00	7536.73

Name	WOB (ft)	Local E (ft)	Local N (ft)	Grid East (US Ft)	Grid North (US Ft)	Latitude	Longitude
Boggess Pad Top	7524.00	-31.15	-47.99	1601441.35	429144.60	39°42'12.460"N	80°52'35.037"W
Boggess Pad Bottom	7892.00	-31.15	-47.99	1601441.35	429144.60	39°42'12.460"N	80°52'35.037"W
Boggess Pad Center	7708.00	-31.15	-47.99	1601441.35	429144.60	39°42'12.460"N	80°52'35.037"W
Boggess Pad Edge	8134.47	842.00	219.54	1602231.28	429249.60	39°42'12.460"N	80°52'35.037"W
Boggess Pad Top	8134.28	842.00	147.48	1602231.28	429249.60	39°42'12.460"N	80°52'35.037"W
Boggess Pad Center	8064.00	-31.15	-47.99	1601441.35	429144.60	39°42'12.460"N	80°52'35.037"W

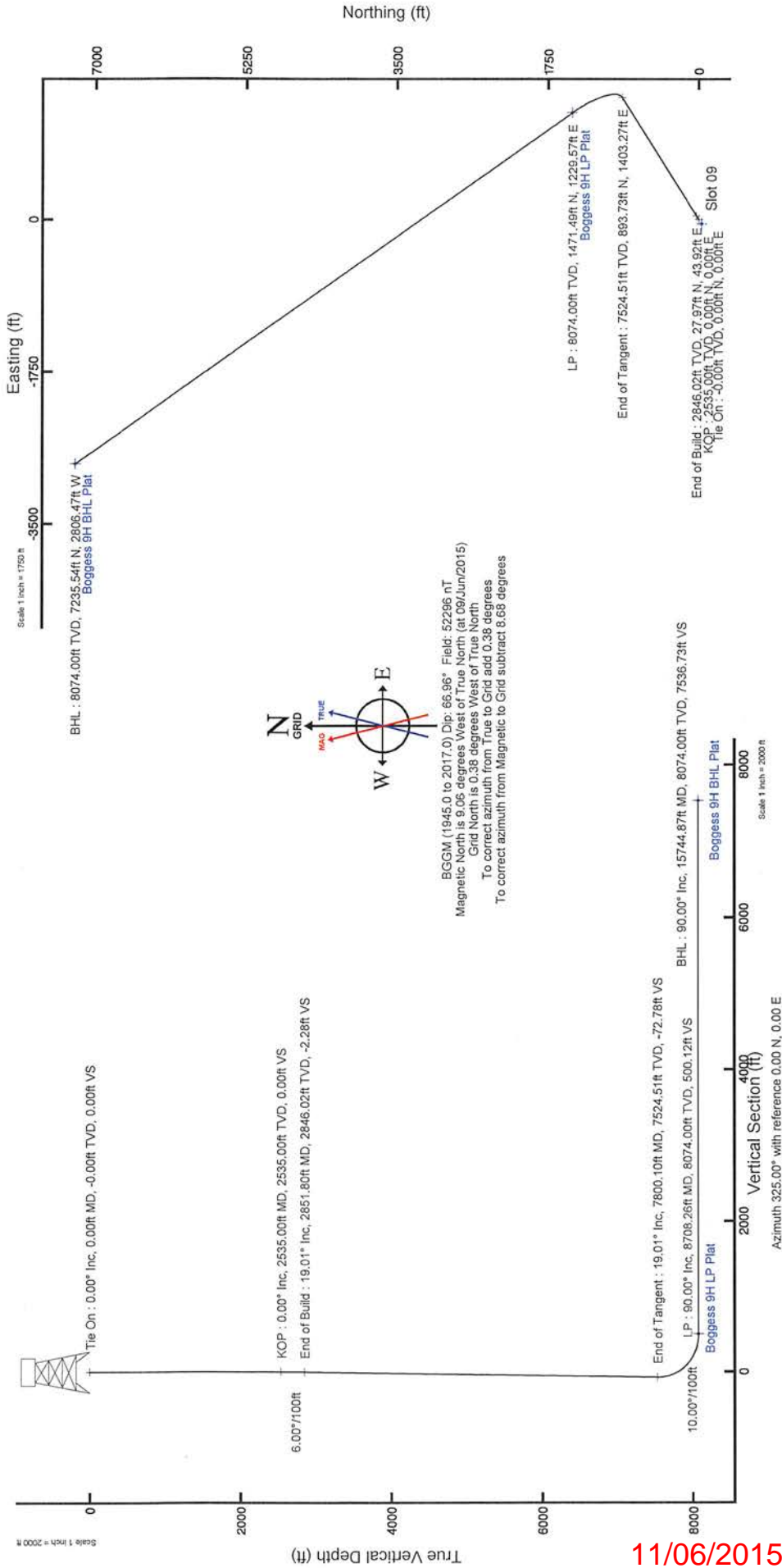

11/06/2015



Clearance Report

Bogges 9H PWP Permit
Closest Approach
Page 1 of 34



REFERENCE WELLPATH IDENTIFICATION

Operator	NORTHEAST NATURAL ENERGY, LLC	Slot	Slot 09
Area	Monongalia County, WV	Well	Bogges 9H
Field	Monongalia	Wellbore	Bogges 9H PWB
Facility	Bogges Pad		

REPORT SETUP INFORMATION

Projection System	NAD83 / Lambert West Virginia SP, Northern Zone (4701), US feet	Software System	WellArchitect® 4.0.1
North Reference	Grid	User	Gotfbral
Scale	0.999941	Report Generated	09/Jun/2015 at 15:40
Convergence at slot	0.38° West	Database/Source file	WANorthEast/Bogges_9H_PWB_CR.xml

WELLPATH LOCATION

	Local coordinates		Grid coordinates		Geographic coordinates	
	North[ft]	East[ft]	Easting[US ft]	Northing[US ft]	Latitude	Longitude
Slot Location	36.10	47.90	1801529.50	426785.70	39°40'12.850"N	80°05'35.420"W
Facility Reference Pt			1801481.60	426749.60	39°40'12.490"N	80°05'36.030"W
Field Reference Pt			1777685.71	440640.65	39°42'28.114"N	80°10'41.690"W

WELLPATH DATUM

Calculation method	Minimum Curvature	Rig on Slot 09 (RT) to Facility Vertical Datum	0.00ft
Horizontal Reference Pt	Slot	Rig on Slot 09 (RT) to Mean Sea Level	1268.00ft
Vertical Reference Pt	Rig on Slot 09 (RT)	Rig on Slot 09 (RT) to Mud Line at Slot (Slot 09)	0.00ft
MD Reference Pt	Rig on Slot 09 (RT)		
Field Vertical Reference	Mean Sea Level		

POSITIONAL UNCERTAINTY CALCULATION SETTINGS

Ellipse Confidence Limit	3.00 Std Dev	Ellipse Start MD	0.00ft	Surface Position Uncertainty	included
Declination	9.06° West of TN	Dip Angle	66.96°	Mag Field Strength	52296 nT
Slot Surface Uncertainty @1SD		Horizontal	0.100ft	Vertical	1.000ft
Facility Surface Uncertainty @1SD		Horizontal	8.200ft	Vertical	3.000ft

Positional Uncertainty values in the WELLPATH DATA table are the projection of the ellipsoid of uncertainty onto the vertical and horizontal planes



Clearance Report

Boggett 9H PWP Permit
Closest Approach



REFERENCE WELLPATH IDENTIFICATION

Operator	NORTHEAST NATURAL ENERGY, LLC	Slot	Slot 09
Area	Monongalia County, WV	Well	Boggett 9H
Field	Monongalia	Wellbore	Boggett 9H PWB
Facility	Boggett Pad		

ANTI-COLLISION RULE

Rule Name	Baker Hughes Stop Drilling	Rule Based On	Ratio
Plane of Rule	Closest Approach	Threshold Value	1.00
Subtract Casing & Hole Size	yes	Apply Cone of Safety	no

SURVEY PROGRAM - Ref Wellbore: Boggett 9H PWB Ref Wellpath: Boggett 9H PWP Permit

Start MD [ft]	End MD [ft]	Positional Uncertainty Model	Log Name/Comment	Wellbore
0.00	2635.00	Generic gyro - northseeking (Standard)		Boggett 9H PWB
2635.00	15744.87	NaviTrak (AT Curve Short Spaced)		Boggett 9H PWB

CALCULATION RANGE & CUTOFF

From: 0.00ft MD	To: 15744.87ft MD	C-C Cutoff: (none)
-----------------	-------------------	--------------------

OFFSET WELL CLEARANCE SUMMARY (4 Offset Wellpaths selected) Ratios are calculated in Closest Approach plane

Offset Facility	Offset Slot	Offset Well	Offset Wellbore	Offset Wellpath	C-C Clearance Distance			ACR Separation Ratio			
					Ref MD [ft]	Min C-C Clear Dist [ft]	Diverging from MD [ft]	Ref MD of Min Ratio [ft]	Min Ratio	Min Ratio Dvrg from [ft]	ACR Status
Boggett Pad	Slot 05	Boggett 5H	Boggett 5H PWB	Boggett 5H PWP Permit	0.00	20.46	2535.00	2543.58	1.00	15744.87	PASS
Boggett Pad	Slot 03	Boggett 3H	Boggett 3H PWB	Boggett 3H PWP Permit	0.00	40.22	15600.00	2552.05	2.04	15700.00	PASS
Boggett Pad	Slot 01	Boggett 1H	Boggett 1H PWB	Boggett 1H PWP Permit	0.00	59.98	15600.00	2545.03	3.36	15744.87	PASS
Boggett Pad	Slot 07	Boggett 7H	Boggett 7H PWB	Boggett 7H PWP Permit	0.00	80.44	2535.00	2570.39	4.14	14900.00	PASS

SURFACE HOLE DEC. LONG: 80.093382
 SURVEYED LONG: 80° 05' 36.2"

2,830'

Latitude: 39° 42' 30" (NAD27)

Longitude: 80° 05' 00" (NAD27)

TOP HOLE (UTM NAD 83)
 N) 4391550.6
 E) 577778.2

BOTTOM HOLE (UTM NAD 83)
 N) 4393740.7
 E) 576886.4

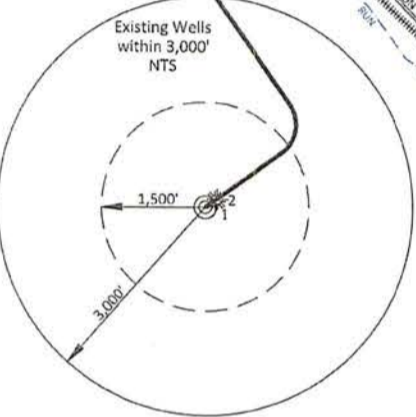
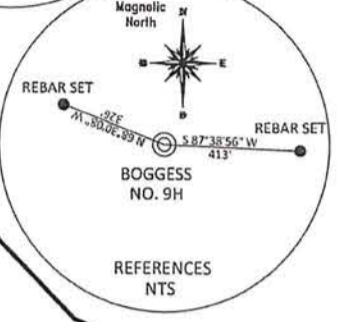
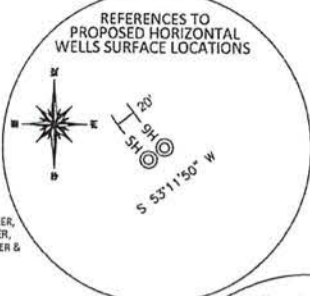
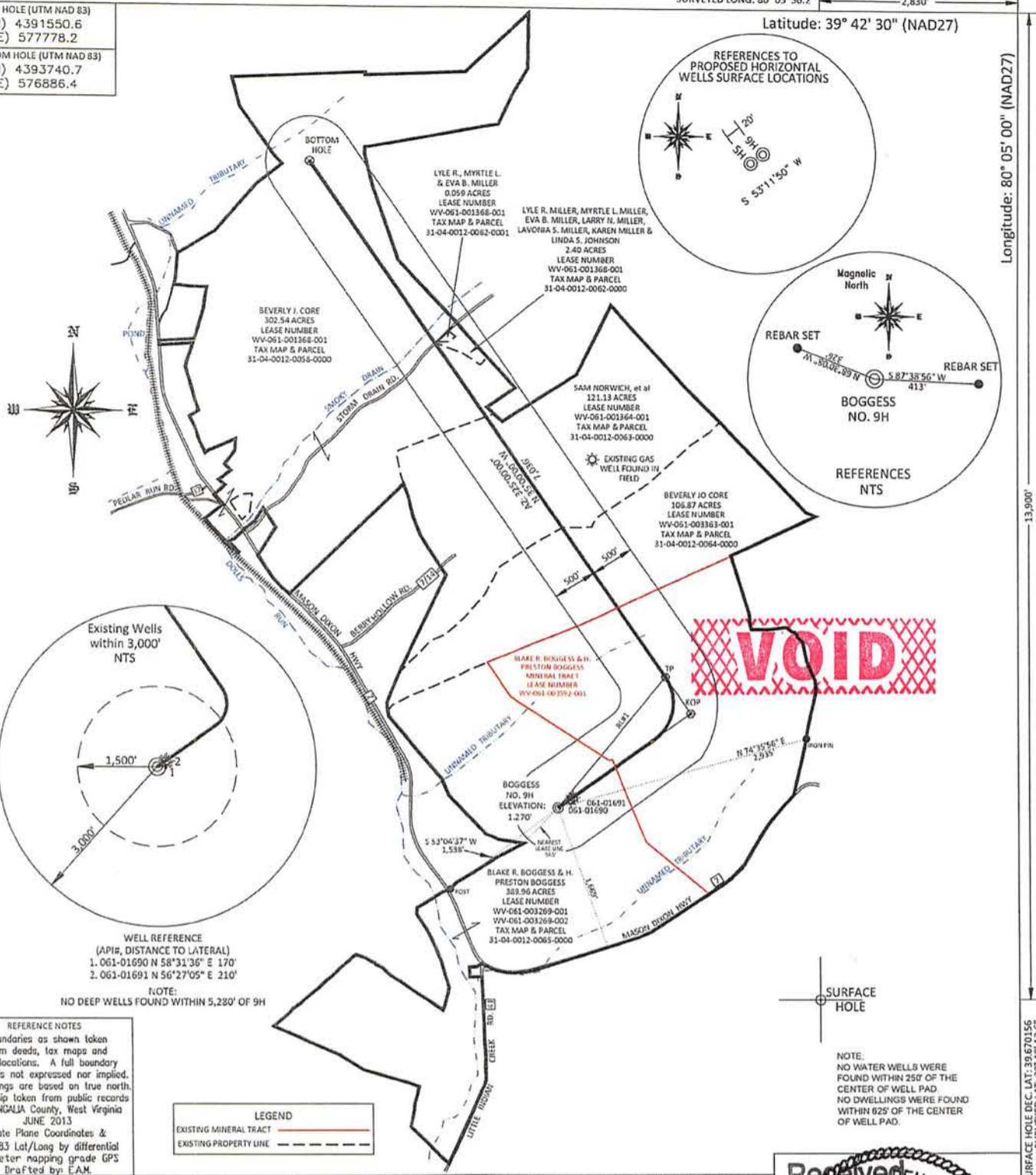

WELL REFERENCE
 (API#, DISTANCE TO LATERAL)
 1. 061-01690 N 58°31'36\"/>

NOTE:
 NO DEEP WELLS FOUND WITHIN 5,280' OF 9H

REFERENCE NOTES
 Boundaries as shown taken from deeds, tax maps and field locations. A full boundary survey is not expressed nor implied. All bearings are based on true north. Ownership taken from public records MONONGALIA County, West Virginia JUNE 2013
 State Plane Coordinates & NAD 83 Lat/Long by differential submeter mapping grade GPS
 Drafted by: E.A.M.

LEGEND
 EXISTING MINERAL TRACT
 EXISTING PROPERTY LINE



NOTE:
 NO WATER WELLS WERE FOUND WITHIN 250' OF THE CENTER OF WELL PAD
 NO DWELLINGS WERE FOUND WITHIN 625' OF THE CENTER OF WELL PAD.

FILE #: NEE14
 DRAWING #: 2459
 SCALE: 1" = 1600'
 TICK MARK: 1" = 2000'

MINIMUM DEGREE OF ACCURACY: 1/200

PROVEN SOURCE SUBMETER MAPPING OF ELEVATION: GRADE GPS

I, THE UNDERSIGNED, HEREBY CERTIFY THAT THIS PLAT IS CORRECT TO THE BEST OF MY KNOWLEDGE AND BELIEF AND SHOWS ALL THE INFORMATION REQUIRED BY LAW AND THE REGULATIONS ISSUED AND PRESCRIBED BY THE DEPARTMENT OF ENVIRONMENTAL PROTECTION.

Signed: *[Signature]*

L.L.S. #2124: Ernest J. Benchek III



(+) DENOTES LOCATION OF WELL ON UNITED STATES TOPOGRAPHIC MAPS WVDPE
 OFFICE OF OIL & GAS
 601 57TH STREET
 CHARLESTON, WV 25304

Well Type: Oil Waste Diposal Production Deep
 Gas Liquid Injection Storage Shallow

WATERSHED: DUNKARD CREEK ELEVATION: 1,268'

COUNTY/DISTRICT: MONONGALIA / CLAY QUADRANGLE: OSAGE, WV

SURFACE OWNER: BLAKE R. & PRESTON H. BOGCESS ACREAGE: 389.96 +/-

OIL & GAS ROYALTY OWNER: BLAKE R. & PRESTON H. BOGCESS ACREAGE: 922.959 +/-

LEASE NUMBERS: _____

DRILL CONVERT DRILL DEEPER REDRILL FRACTURE OR STIMULATE
 PLUG OFF FORMATION PERFORATE NEW FORMATION PLUG & ABANDON
 CLEAN OUT & REPLUG OTHER CHANGE (SPECIFY): _____

TARGET FORMATION: MARCELLUS ESTIMATED DEPTH: TVD PILOT: 8,500'
 TMD: 16,605' TVD HORIZ: 8,092'

WELL OPERATOR: NORTHEAST NATURAL ENERGY LLC DESIGNATED AGENT: JOHN ADAMS
 ADDRESS: 707 VIRGINIA STREET EAST, SUITE 1200 ADDRESS: 707 VIRGINIA STREET EAST, SUITE 1200
 CITY: CHARLESTON STATE: WV ZIP CODE: 25301 CITY: CHARLESTON STATE: WV ZIP CODE: 25301

11/06/2015

SURFACE HOLE DEC. LAT: 39.670156
 SURVEYED LAT: 39° 40' 12.6"

WELL NAME: BOGGESS NO. 9H
OSAGE, WV

VOID

11/06/2015

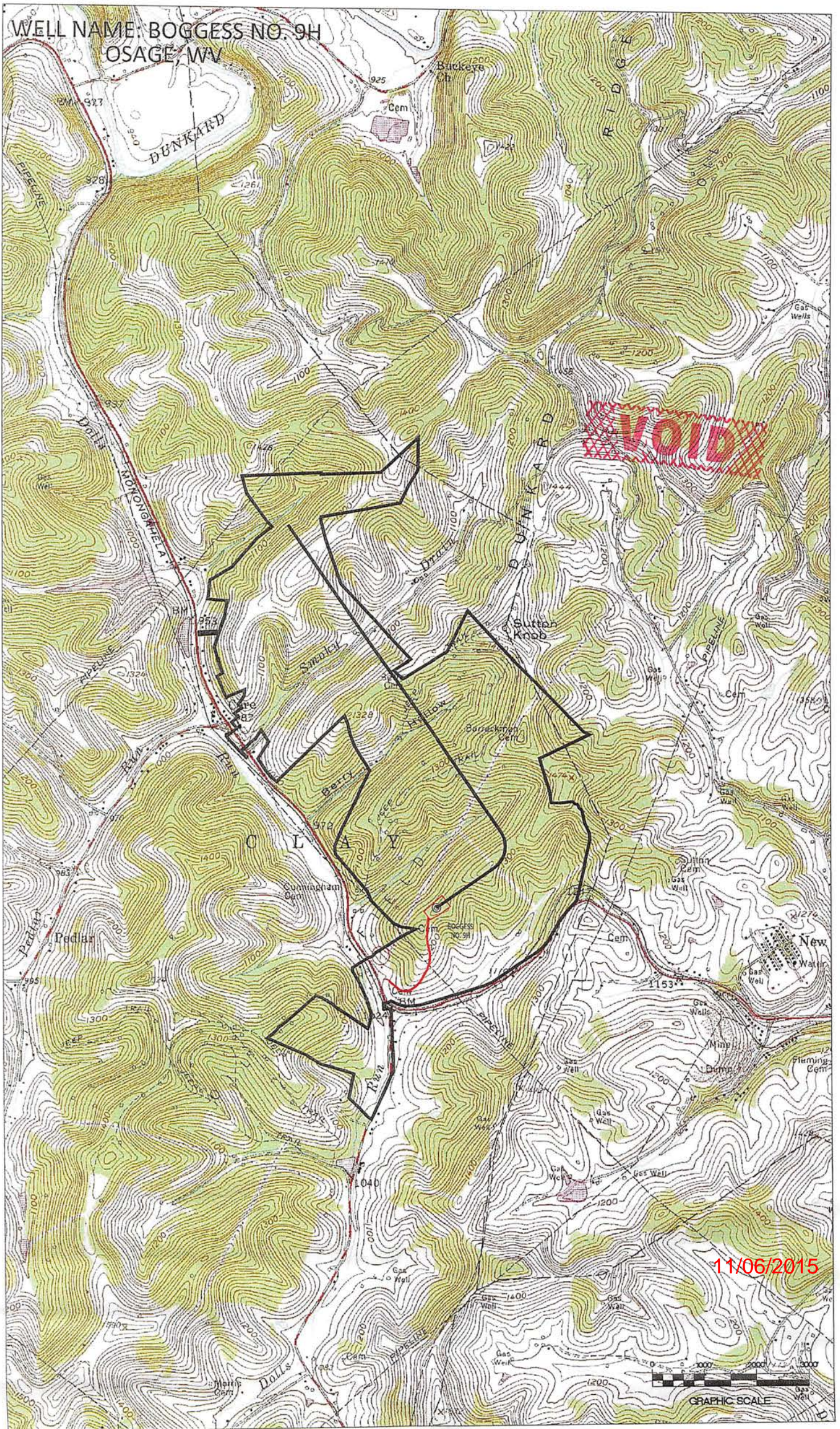

WW-6A
(8-13)

API NO. 47- _____ - _____
OPERATOR WELL NO. Boggess 9H
Well Pad Name: Boggess

Notice is hereby given by:

Well Operator: Northeast Natural Energy LLC
Telephone: 304-241-5752, ext. 7108
Email: hmedley@nne-llc.com

Address: 707 Virginia Street E., Suite 1200
Charleston, WV 25301
Facsimile: 304-241-5972

Oil and Gas Privacy Notice:

The Office of Oil and Gas processes your personal information, such as name, address and telephone number, as part of our regulatory duties. Your personal information may be disclosed to other State agencies or third parties in the normal course of business or as needed to comply with statutory or regulatory requirements, including Freedom of Information Act requests. Our office will appropriately secure your personal information. If you have any questions about our use or your personal information, please contact DEP's Chief Privacy Officer at deprivacyofficer@wv.gov.

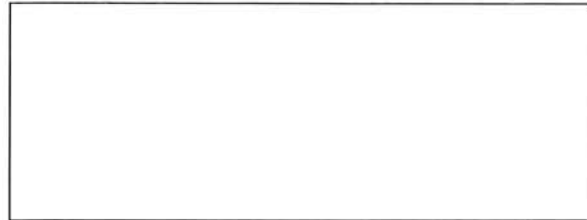

Subscribed and sworn before me this _____ day of _____, _____.

_____ Notary Public

My Commission Expires _____



Received
Office of Oil & Gas
JUL 14 2015

11/06/2015

18) CASING AND TUBING PROGRAM

TYPE	Size (in)	New or Used	Grade	Weight per ft. (lb/ft)	FOOTAGE: For Drilling (ft)	INTERVALS: Left in Well (ft)	CEMENT: Fill-up (Cu. Ft.)/CTS
Conductor	24"	New	NA	94.71	60'	60'	GTS
Fresh Water	13-3/8"	New	J-55	54.5	1,290'	1,260'	CTS
Coal							
Intermediate	9-5/8"	New	J-55	40	2,530'	2,500'	CTS
Production	5-1/2"	New	P-110	20	16,605'	16,575'	3,824 Cu. Ft.
Tubing	2-7/8"	New	N-80	6.5	NA	8,500'	NA
Liners							

Northeast Natural Energy LLC requests the ability to drill beyond elevation for the purpose of isolating the Red Rock Formation.

MJK 6/17/2015

TYPE	Size (in)	Wellbore Diameter (in)	Wall Thickness (in)	Burst Pressure (psi)	Anticipated Max. Internal Pressure (psi)	Cement Type	Cement Yield (cu. ft./k)
Conductor	24"	30"	.375	415		4,500 pst Grout	NA
Fresh Water	13-3/8"	17 1/2"	.38"	2,760	2,000	Class A	1.23
Coal							
Intermediate	9-5/8"	12 1/4"	.395"	3,950	3,000	Class A	1.3
Production	5-1/2"	8 3/4"	.361"	12,530	9,700	50:50 Poz	1.21
Tubing	2-7/8"	NA	.217"	10,570	3,600	NA	NA
Liners							

PACKERS

Kind:				
Sizes:				
Depths Set:				

Received
 Office of Oil & Gas
 JUL 14 2015